

GDM-F500/F500T9

SERVICE MANUAL

REVISED

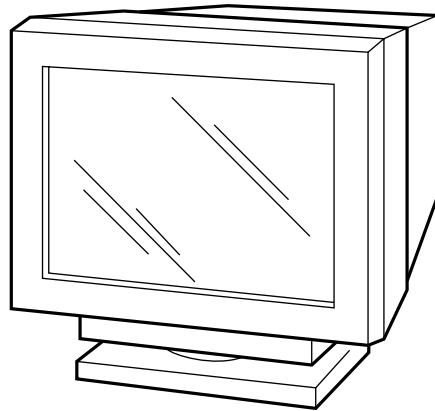

GDM-F500
US Model
Canadian Model
AEP Model
Chassis No. SCC-L03C-A

GDM-F500T9
AEP Model
Chassis No. SCC-L03CA

N3P CHASSIS

SPECIFICATIONS

CRT	0.22 mm aperture grille pitch 21 inches measured diagonally 90-degree deflection FD Trinitron	Deflection frequency*	Horizontal: 30 to 121 kHz Vertical: 48 to 160 Hz
Viewable image size	Approx. 403.8 × 302.2 mm (w/h) (16 × 12 inches) 19.8" viewing image	AC input voltage/current Power consumption	100 to 240 V, 50 – 60 Hz, 2.0 – 1.0 A Max. 160 W (with no USB devices connected)
Resolution	Horizontal: Max. 1800 dots Vertical: Max. 1440 lines	Dimensions	Approx. 502 × 511 × 486.3 mm (w/h/d) (19 7/8 × 20 1/8 × 19 1/4 inches)
Standard image area	Approx. 388 × 291 mm (w/h) (15 3/8 × 11 1/2 inches) or Approx. 364 × 291 mm (w/h) (14 3/8 × 11 1/2 inches)	Mass Plug and Play	Approx. 34 kg (74 lb 15 oz) DDC1/DDC2B/DDC2AB/DDC2B+

- * Recommended horizontal and vertical timing condition
- Horizontal sync width duty should be more than 4.8% of total horizontal time or 0.8 μ s, whichever is larger.
 - Horizontal blanking width should be more than 2.5 μ sec.
 - Vertical blanking width should be more than 450 μ sec.

Design and specifications are subject to change without notice.

TRINITRON® COLOR GRAPHIC DISPLAY



SONY®

After correcting the original service problem, perform the following safety checks before releasing the set to the customer:

1. Check the area of your repair for unsoldered or poorly-soldered connections. Check the entire board surface for solder splashes and bridges.
2. Check the interboard wiring to ensure that no wires are "pinched" or contact high-wattage resistors.
3. Check that all control knobs, shields, covers, ground straps, and mounting hardware have been replaced. Be absolutely certain that you have replaced all the insulators.
4. Look for unauthorized replacement parts, particularly transistors, that were installed during a previous repair. Point them out to the customer and recommend their replacement.
5. Look for parts which, though functioning, show obvious signs of deterioration. Point them out to the customer and recommend their replacement.
6. Check the line cords for cracks and abrasion. Recommend the replacement of any such line cord to the customer.
7. Check the B+ and HV to see if they are specified values. Make sure your instruments are accurate; be suspicious of your HV meter if sets always have low HV.
8. Check the antenna terminals, metal trim, "metallized" knobs, screws, and all other exposed metal parts for AC Leakage. Check leakage as described below.

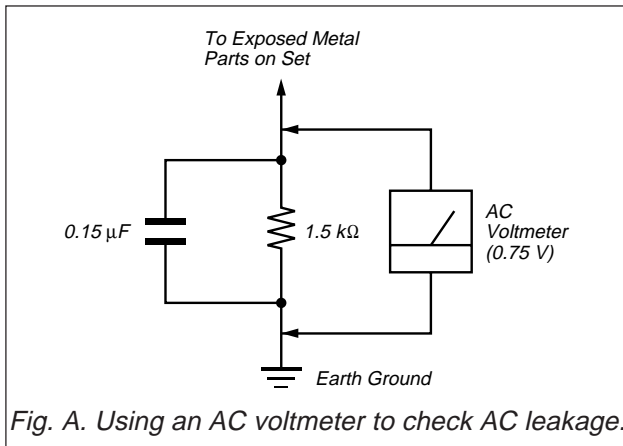

CAUTION ON DAS (ECS) CONNECTOR

- The connector for DAS (ECS) adjustment is provided inside the cover shown below. Be careful with an electrical shock when connecting the connector with the power supplied. Also, return the removed cover to the home position.

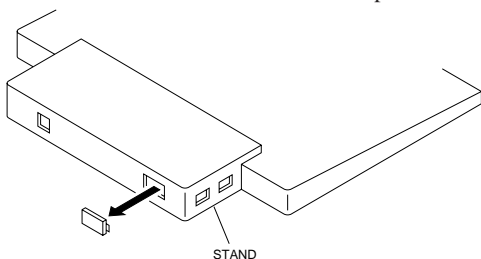

LEAKAGE TEST

The AC leakage from any exposed metal part to earth ground and from all exposed metal parts to any exposed metal part having a return to chassis, must not exceed 0.5 mA (500 microamperes).

Leakage current can be measured by any one of three methods.

1. A commercial leakage tester, such as the Simpson 229 or RCA WT-540A. Follow the manufacturers' instructions to use these instruments.
2. A battery-operated AC milliammeter. The Data Precision 245 digital multimeter is suitable for this job.
3. Measuring the voltage drop across a resistor by means of a VOM or battery-operated AC voltmeter. The "limit" indication is 0.75 V, so analog meters must have an accurate low-voltage scale. The Simpson 250 and Sanwa SH-63Trd are examples of a passive VOMs that are suitable. Nearly all battery operated digital multimeters that have a 2 V AC range are suitable. (See Fig. A)

WARNING!!

NEVER TURN ON THE POWER IN A CONDITION IN WHICH THE DEGAUSS COIL HAS BEEN REMOVED.

SAFETY-RELATED COMPONENT WARNING!!

COMPONENTS IDENTIFIED BY SHADING AND MARK \triangle ON THE SCHEMATIC DIAGRAMS, EXPLODED VIEWS AND IN THE PARTS LIST ARE CRITICAL FOR SAFE OPERATION. REPLACE THESE COMPONENTS WITH SONY PARTS WHOSE PART NUMBERS APPEAR AS SHOWN IN THIS MANUAL OR IN SUPPLEMENTS PUBLISHED BY SONY. CIRCUIT ADJUSTMENTS THAT ARE CRITICAL FOR SAFE OPERATION ARE IDENTIFIED IN THIS MANUAL. FOLLOW THESE PROCEDURES WHENEVER CRITICAL COMPONENTS ARE REPLACED OR IMPROPER OPERATION IS SUSPECTED.

AVERTISSEMENT!!

NE JAMAIS METTRE SOUS TENSION QUAND LA BOBINE DE DEMAGNETISATION EST ENLEVÉE.

ATTENTION AUX COMPOSANTS RELATIFS À LA SÉCURITÉ!!

LES COMPOSANTS IDENTIFIÉS PAR UNE TRAME ET UNE MARQUE \triangle SONT CRITIQUES POUR LA SÉCURITÉ. NE LES REMPLACER QUE PAR UNE PIÈCE PORTANT LE NUMÉRO SPECIFIÉ. LES RÉGLAGES DE CIRCUIT DONT L'IMPORTANCE EST CRITIQUE POUR LA SÉCURITÉ DU FONCTIONNEMENT SONT IDENTIFIÉS DANS LE PRÉSENT MANUEL. SUIVRE CES PROCÉDURES LORS DE CHAQUE REMPLACEMENT DE COMPOSANTS CRITIQUES, OU LORSQU'UN MAUVAIS FONCTIONNEMENT EST SUSPECTÉ.

POWER SAVING FUNCTION

This monitor meets the power-saving guidelines set by VESA, ENERGY STAR, and NUTEK. If the monitor is connected to a computer or video graphics board that is DPMS (Display Power Management Signaling) compliant, the monitor will automatically reduce power consumption in three stages as shown below.

Power mode	Power consumption*	⏻ (power) indicator
normal operation	≤ 160 W	green
1 standby	≤ 100 W	green and orange alternate
2 suspend	≤ 15 W	green and orange alternate
3 active off**	≤ 1 W	orange
power off	0 W	off

* Figures reflect power consumption when no USB compatible peripherals are connected to the monitor.

**When your computer enters the “active off” mode, the input signal is cut and NO INPUT SIGNAL appears on the screen. After the time set in “Changing the power saving delay time.” (page 1-6) has elapsed, the monitor enters the power saving mode.

To change the power saving delay time

See page 1-6.

DIAGNOSIS

This monitor is equipped with a self-diagnosis function. If there is a problem with your monitor or computer(s), the screen will go blank and the ⏻ (power) indicator will either light up green or flash orange. If the ⏻ (power) indicator is lit in orange, the computer is in power saving mode. Try pressing any key on the keyboard.

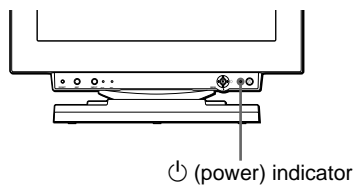

If all four color bars appear (white, red, green, blue), the monitor is working properly. Reconnect the video input cables and check the condition of your computer(s).

If the color bars do not appear, there is a potential monitor failure. Inform your authorized Sony dealer of the monitor's condition.

If the ⏻ (power) indicator is flashing orange

Press the ⏻ (power) button to turn the monitor off and on.

If the ⏻ (power) indicator lights up green, the monitor is working properly.

If the ⏻ (power) indicator is still flashing, there is a potential monitor failure. Count the number of seconds between orange flashes of the ⏻ (power) indicator and inform your authorized Sony dealer of the monitor's condition. Be sure to note the model name and serial number of your monitor. Also note the make and model of your computer and video board.

If the ⏻ (power) indicator is green

- 1 Remove any plugs from the video input 1 and 2 connectors, or turn off the connected computer(s).**
- 2 Press the ⏻ (power) button to turn the monitor off and on.**
- 3 Move the joystick to the right for 2 seconds before the monitor enters power saving mode.**

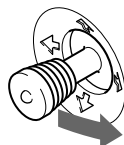

TIMING SPECIFICATION

MODE AT PRODUCTION	MODE 1	MODE 2	MODE 3	MODE 4	MODE 5
RESOLUTION	738 X 414	1600 X 1200	1800 X 1440	1800 X 1350	1364 X 1201
CLOCK	28.322 MHZ	229.500 MHZ	299.436 MHZ	299.000 MHZ	195.500 MHZ
— HORIZONTAL —					
H-FREQ	31.469 kHz	106.250 kHz	120.740 kHz	120.565 kHz	106.250 kHz
	usec	usec	usec	usec	usec
H. TOTAL	31.777	9.412	8.282	8.294	9.412
H. BLK	5.720	2.440	2.271	2.274	2.435
H. FP	0.318	0.279	0.668	0.669	0.276
H. SYNC	3.813	0.837	0.481	0.482	0.839
H. BP	1.589	1.325	1.122	1.124	1.320
H. ACTIV	26.057	6.972	6.011	6.020	6.977
— VERTICAL —					
V. FREQ(HZ)	70.087 Hz	85.000 Hz	80.120 Hz	85.084 Hz	85.000 Hz
	lines	lines	lines	lines	lines
V. TOTAL	449	1250	1507	1417	1250
V. BLK	35	50	67	67	49
V. FP	5	1	1	1	1
V. SYNC	2	3	3	3	3
V. BP	28	46	63	63	45
V. ACTIV	414	1200	1440	1350	1201
— SYNC —					
INT(G)	NO	NO	NO	NO	NO
EXT(H/V)/POLARITY	YES N/P	YES P/P	YES P / P	YES P / P	YES P/P
EXT(CS) /POLARITY	NO	NO	NO	NO	NO
INT/NON INT	NON INT	NON INT	NON INT	NON INT	NON INT
SIZE (21")	388 X 291mm	388 X 291mm	364 X 291mm	388 X 291mm	388 X 291 mm

98. 4.27 VER.

TABLE OF CONTENTS

<i>Section</i>	<i>Title</i>	<i>Page</i>
1. GENERAL		1-1
2. DISASSEMBLY		
2-1.	Cabinet Removal	2-1
2-2.	D Board Removal	2-1
2-3.	G Board Removal	2-2
2-4.	A Board Removal	2-2
2-5.	L Board Removal	2-3
2-6.	Service Position	2-3
2-7.	H1, H2 and J Boards Removal	2-4
2-8.	US Board Removal	2-4
2-9.	Picture Tube Removal	2-5
2-10.	Harness Location	2-6
3. SAFETY RELATED ADJUSTMENT		3-1
4. ADJUSTMENTS		4-1
5. DIAGRAMS		
5-1.	Block Diagrams	5-1
5-2.	Frame Schematic Diagram	5-7
5-3.	Circuit Boards Location	5-9
5-4.	Schematic Diagrams and Printed Wiring Boards	5-9
(1)	Schematic Diagrams of D (1/2, 2/2) Board	5-13
(2)	Schematic Diagrams of G, H1, H2, J and L Boards	5-17
(3)	Schematic Diagram of A Board	5-24
(4)	Schematic Diagram of US Board (-11) (OLD)	5-29
(5)	Schematic Diagram of US Board (-12, -13) (NEW)	5-33
5-5.	Semiconductors	5-35
6. EXPLODED VIEWS		
6-1.	Chassis	6-1
6-2.	Picture Tube	6-2
6-3.	Packing Materials	6-3
7. ELECTRICAL PARTS LIST		7-1

Note: Hand degauss must be used on stand-by or power-off condition.

This model has an automatic earth magnetism correction function by using an earth magnetism sensor and a LCC coil. When using a hand degauss while monitor (LCC coil) is being operated, it sometimes gets magnetized, and the system may not work properly as a result.

The operating instructions mentioned here are partial abstracts from the Operating Instruction Manual. The page numbers of the Operating Instruction Manual remain as in the manual.

SECTION 1 GENERAL

Precautions

Warning on power connections

- Use the supplied power cord. If you use a different power cord, be sure that it is compatible with your local power supply.
- For the customers in the U.S.A.**
If you do not use the appropriate cord, this monitor will not conform to mandatory FCC standards.

Example of plug types

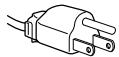

for 100 to 120 V AC

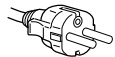

for 200 to 240 V AC

- Before disconnecting the power cord, wait at least 30 seconds after turning off the power to allow the static electricity on the screen's surface to discharge.
- After the power is turned on, the screen is demagnetized (degaussed) for about 3 seconds. This generates a strong magnetic field around the screen which may affect data stored on magnetic tapes and disks placed near the monitor. Be sure to keep magnetic recording equipment, tapes, and disks away from the monitor.

The equipment should be installed near an easily accessible outlet.

Installation

Do not install the monitor in the following places:

- on surfaces (rugs, blankets, etc.) or near materials (curtains, draperies, etc.) that may block the ventilation holes
- near heat sources such as radiators or air ducts, or in a place subject to direct sunlight
- in a place subject to severe temperature changes
- in a place subject to mechanical vibration or shock
- on an unstable surface
- near equipment which generates magnetism, such as a transformer or high voltage power lines
- near or on an electrically charged metal surface

Maintenance

- Clean the screen with a soft cloth. If you use a glass cleaning liquid, do not use any type of cleaner containing an anti-static solution or similar additive as this may scratch the screen's coating.
- Do not rub, touch, or tap the surface of the screen with sharp or abrasive items such as a ballpoint pen or screwdriver. This type of contact may result in a scratched picture tube.
- Clean the cabinet, panel and controls with a soft cloth lightly moistened with a mild detergent solution. Do not use any type of abrasive pad, scouring powder or solvent, such as alcohol or benzene.

Transportation

When you transport this monitor for repair or shipment, use the original carton and packing materials.

Use of the tilt-swivel

This monitor can be adjusted within the angles shown below. To turn the monitor vertically or horizontally, hold it at the bottom with both hands.

GDM-F400

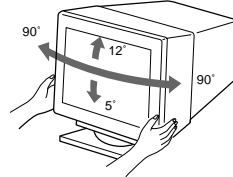

GDM-F500

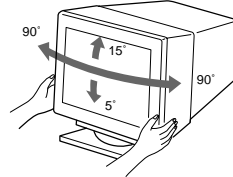

Identifying parts and controls

See the pages in parentheses for further details. GDM-F500 is used for illustration purposes throughout this manual.

Front

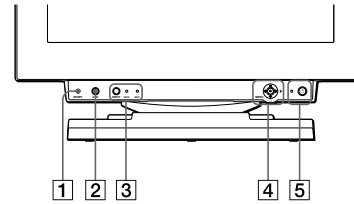

- RESET button (page 14)**
This button resets the adjustments to the factory settings.
- ASC (auto sizing and centering) button (page 9)**
This button automatically adjusts the size and centering of the picture.
- INPUT button and HD 15/BNC indicators (page 9)**
This button selects the HD15 or BNC video input signal. The input signal and corresponding input indicator change each time you press this button.
- Joystick (page 11)**
The joystick is used to display the menu and make adjustments to the monitor, including brightness and contrast adjustments.
- (power) switch and indicator (pages 7, 15, 18)**
This button turns the monitor on and off. The power indicator lights up in green when the monitor is turned on, and either flashes in green and orange, or lights up in orange when the monitor is in power saving mode.
- AC IN connector (page 7)**
This connector provides AC power to the monitor.
- USB (universal serial bus) upstream connector (page 8)**
Use this connector to link the monitor to a USB compliant computer.
- USB (universal serial bus) downstream connectors (page 8)**
Use these connectors to link USB peripheral devices to the monitor.

Rear

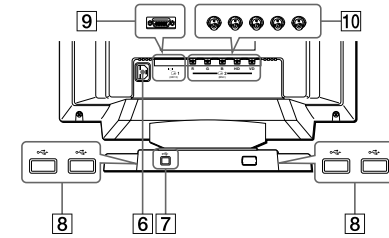

- Video input 1 connector (HD15) (page 6)**
This connector inputs RGB video signals (0.700 Vp-p, positive) and sync signals.



Pin No.	Signal
1	Red
2	Green (Composite Sync on Green)
3	Blue
4	ID (Ground)
5	DDC Ground*
6	Red Ground
7	Green Ground
8	Blue Ground
9	DDC + 5V*
10	Ground
11	ID (Ground)
12	Bi-Directional Data (SDA)*
13	H. Sync
14	V. Sync
15	Data Clock (SCL)*

* DDC (Display Data Channel) is a standard of VESA.

- Video input 2 connector (BNC) (page 6)**
This connector inputs RGB video signals (0.700 Vp-p, positive) and sync signals.

Setup

Before using your monitor, check that the following accessories are included in your carton:

- Power cord (1)
- HD15 video signal cable (1)
- USB cable (1)
- Macintosh adapter (1)
- Windows Monitor Information Disk (1)
- Warranty card (1)
- Notes on cleaning the screen's surface (1)
- This instruction manual (1)

Step 1: Connect your monitor to your computer

Turn off the monitor and computer before connecting.

■ Connecting to an IBM PC/AT or compatible computer

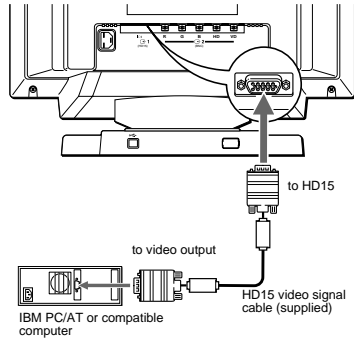

If your PC system is not compatible with Plug & Play (DDC2AB or DDC2B+)

This monitor uses the No.9 pin in the video signal connector for Plug & Play (DDC2AB or DDC2B+) compatibility. See page 5 for the location of the No.9 pin.

- If your computer accepts the No.9 pin, use the supplied HD15 video signal cable.
- If your computer does not accept the No.9 pin, please consult your dealer for advice on obtaining an HD15 adapter.

■ Connecting to a Macintosh or compatible computer

Use the supplied Macintosh adapter.

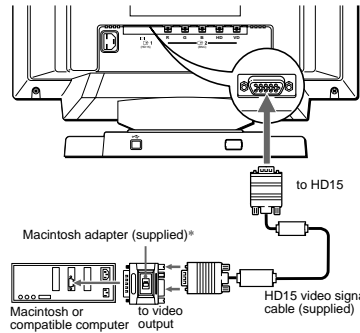

* Connect the supplied Macintosh adapter to the computer before connecting the cable. This adapter is compatible with Macintosh LC, Performa, Quadra, Power Macintosh and Power Macintosh G3 series computers. Macintosh II series and some older versions of PowerBook models may need an adapter with micro switches (not supplied).

■ Connecting to the five BNC connectors

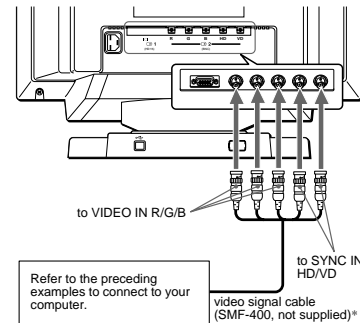

* Connect the cables from left to right in the following order: Red-Green-Blue-HD-VD.

Notes

- Do not touch the pins of the video cable connector as this might bend the pins.
- Plug & Play (DDC) does not apply to the five BNC connectors. If you want to use Plug & Play, connect your computer to the HD15 connector using the supplied video signal cable.

Step 2: Connect the power cord

With the monitor and computer switched off, first connect the power cord to the monitor, then connect it to a power outlet.

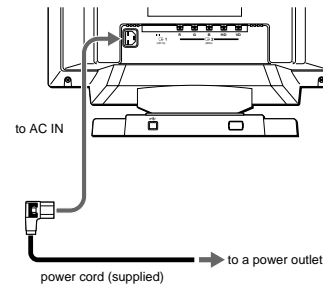

Step 3: Turn on the monitor and computer

First turn on the monitor, then turn on the computer.



The installation of your monitor is complete. If necessary, use the monitor's controls to adjust the picture.

If no picture appears on your screen

- Check that the monitor is correctly connected to the computer.
- If NO INPUT SIGNAL appears on the screen, try changing the input signal (page 9), and confirm that your computer's graphic board is completely seated in the correct bus slot.
- If you are replacing an old monitor with this model and OUT OF SCAN RANGE appears on the screen, reconnect the old monitor. Then adjust the computer's graphic board so that the horizontal frequency is between 30 – 107 kHz (GDM-F400) or 30 – 121 kHz (GDM-F500), and the vertical frequency is between 48 – 160 Hz.

For more information about the on-screen messages, see "Trouble symptoms and remedies" on page 16.

For customers using Windows 95/98

To maximize the potential of your monitor, install the new model information file from the supplied Windows Monitor Information Disk onto your PC.

This monitor complies with the "VESA DDC" Plug & Play standard. If your PC/graphics board complies with DDC, select "Plug & Play Monitor (VESA DDC)" or this monitor's model name as the monitor type in the "Control Panel" of Windows 95/98. If your PC/graphics board has difficulty communicating with this monitor, load the Windows Monitor Information Disk and select this monitor's model name as the monitor type.

For customers using Windows NT4.0

Monitor setup in Windows NT4.0 is different from Windows 95/98 and does not involve the selection of monitor type. Refer to the Windows NT4.0 instruction manual for further details on adjusting the resolution, refresh rate, and number of colors.

Adjusting the monitor's resolution and color number

Adjust the monitor's resolution and color number by referring to your computer's instruction manual. The color number may vary according to your computer or video board. The color palette setting and the actual number of colors are as follows:

- High Color (16 bit) → 65,536 colors
 - True Color (24 bit) → about 16.77 million colors
- In true color mode (24 bit), speed may be slower.

Connecting Universal Serial Bus (USB) compliant peripherals

Your monitor has one upstream and four downstream USB connectors. They provide a fast and easy way to connect USB compliant peripheral devices (such as keyboards, mice, printers and scanners) to your computer using a standardized USB cable. To use your monitor as a hub for your peripheral devices, connect the USBs as illustrated below.

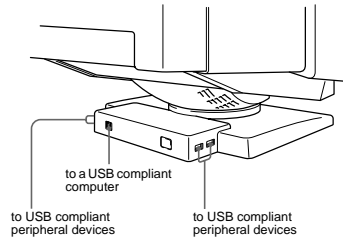

- 1 Turn on the monitor and computer.
- 2 Connect your computer to the square upstream connector using the supplied USB cable.

For customers using Windows

If a message appears on your screen, follow the on-screen instructions and select Generic USB Hub as the default setting.

- 3 Connect your USB compliant peripheral devices to the rectangular downstream USB connectors.

Notes

- Not all computers and /or operating systems support USB configurations. Check your computer's instruction manual to see if you can connect USB devices.
- In most cases, USB driver software needs to be installed on the host computer. Refer to the peripheral device's instruction manual for further details.
- The monitor functions as a USB hub as long as the monitor is either "on" or in power saving mode.
- If you connect a keyboard or mouse to the USB connectors and then boot your computer for the first time, the peripheral devices may not function. First connect the keyboard and mouse directly to the computer and set up the USB compliant devices. Then connect them to this monitor.
- Do not lean on the monitor when plugging in the USB cables. The monitor may suddenly shift and cause injury.

Selecting the on-screen menu language (LANG)

English, French, German, Spanish, Italian, and Japanese versions of the on-screen menus are available. The default setting is English.

- 1 Press the joystick

See page 11 for more information on using the joystick.

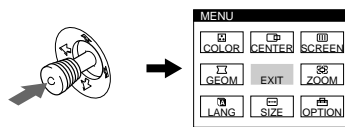

- 2 Move the joystick to highlight LANG and press the joystick again.

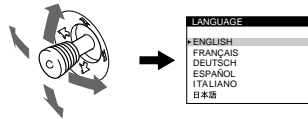

- 3 Move the joystick up or down to select a language and press the joystick again.

- ENGLISH
- FRANÇAIS: French
- DEUTSCH: German
- ESPAÑOL: Spanish
- ITALIANO: Italian
- 日本語: Japanese

To close the menu

Press the joystick once to return to the main menu, and twice to return to normal viewing. If no buttons are pressed, the menu closes automatically after about 30 seconds.

To reset to English

Press the RESET button while the LANGUAGE menu is displayed on the screen.

Selecting the input signal

You can connect two computers to this monitor using the HD15 and BNC connectors. To switch between the two computers, use the INPUT button.

Press the INPUT button.

The input signal and corresponding input indicator change each time you press this button.



Notes

- If no signal is input to the selected connector, the monitor automatically switches to the other connector.
- If you restart the computer you want to view, or that computer is in power saving mode, the monitor may automatically switch to the other connector's signal. If this happens, manually select the desired signal using the INPUT button.

Automatically sizing and centering the picture

You can easily adjust the picture to fill the screen by pressing the ASC (auto sizing and centering) button.

Press the ASC button.

The picture automatically fills the screen.

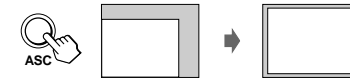

Notes

- This function is intended for use with a computer running Windows or similar graphic user interface software that provides a full-screen picture. It may not work properly if the background color is dark or if the input picture does not fill the screen to the edges (such as an MS-DOS prompt).
- Pictures with an aspect ratio of 5:4 (resolution: 1280 × 1024, 1800 × 1440*) are displayed at their actual resolution and do not fill the screen to the edges.
- The screen may go blank for a few seconds when the ASC button is pressed. This is not a malfunction.

* GDM-F500 only

EN

Customizing Your Monitor

You can make numerous adjustments to your monitor using the on-screen menu.

Navigating the menu

Press the joystick to display the main MENU on your screen. See page 11 for more information on using the joystick.

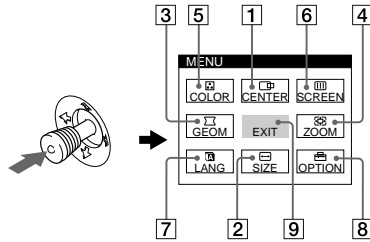

Use the joystick to select one of the following menus.

1 CENTER (page 11)

Select the CENTER menu to adjust the picture's centering.

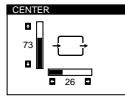

2 SIZE (page 11)

Select the SIZE menu to adjust the picture's horizontal and vertical size.

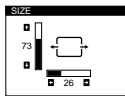

3 GEOM (page 12)

Select the GEOM menu to adjust the picture's rotation and shape.

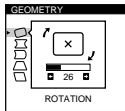

4 ZOOM (page 12)

Select the ZOOM menu to enlarge or reduce the picture.

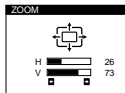

5 COLOR (page 12)

Select the COLOR menu to adjust the picture's color temperature. You can use this to match the monitor's colors to a printed picture's colors.

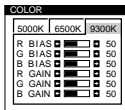

6 SCREEN (page 13)

Select the SCREEN menu to adjust the picture's quality. You can adjust the vertical and horizontal convergence, landing, and more cancellation effect.

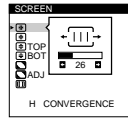

7 LANG (page 8)

Select LANG to choose the on-screen menu's language.



8 OPTION (page 14)

Select OPTION to adjust the monitor's options. The options include:

- degaussing the screen
- changing the on-screen menu position
- changing the power saving delay time
- locking the controls

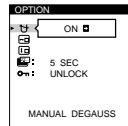

9 EXIT

Select EXIT to close the menu.

Using the joystick

1 Select the menu you want to adjust.

Move the joystick up, down, left, or right to highlight the desired menu. Press the joystick to select the menu item.

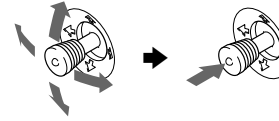

2 Adjust the menu.

Move the joystick up, down, left, or right to make the adjustment.

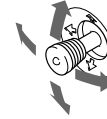

3 Close the menu.

Press the joystick once to return to the main menu, and twice to return to normal viewing. If no buttons are pressed, the menu closes automatically after about 30 seconds.

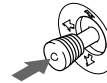

Resetting the adjustments

Press the RESET button. See page 14 for more information on resetting the adjustments.



Adjusting the brightness and contrast

Brightness and contrast adjustments are made using a separate BRIGHTNESS/CONTRAST menu. These settings are stored in memory for all input signals.

1 Move the joystick in any direction.

The BRIGHTNESS/CONTRAST menu appears on the screen.

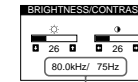

the horizontal and vertical frequencies of the current input signal

2 Move the joystick up or down to adjust the brightness (☉), and left or right to adjust the contrast (☉).

The menu automatically disappears after about 3 seconds.

Adjusting the centering of the picture (CENTER)

EN

This setting is stored in memory for the current input signal.

1 Press the joystick.

The main MENU appears on the screen.

2 Move the joystick to highlight ☐ CENTER and press the joystick again.

The CENTER menu appears on the screen.

3 Move the joystick up or down to adjust the vertical centering, and left or right to adjust the horizontal centering.

Adjusting the size of the picture (SIZE)

This setting is stored in memory for the current input signal.

1 Press the joystick.

The main MENU appears on the screen.

2 Move the joystick to highlight ☐ SIZE and press the joystick again.





The SIZE menu appears on the screen.

3 Move the joystick up or down to adjust the vertical size, and left or right to adjust the horizontal size.

Adjusting the shape of the picture (GEOM)

The GEOM settings allow you to adjust the rotation and shape of the picture.
The rotation setting is stored in memory for all input signals. All other settings are stored in memory for the current input signal.

- 1 Press the joystick.**
The main MENU appears on the screen.
- 2 Move the joystick to highlight  GEOM and press the joystick again.**
The GEOMETRY menu appears on the screen.
- 3 First move the joystick up or down to select the desired adjustment item. Then move the joystick left or right to make the adjustment.**

Select	To
 ROTATION	rotate the picture
 PINCUSHION	expand or contract the picture sides
 PIN BALANCE	shift the picture sides to the left or right
 KEYSTONE	adjust the picture width at the top of the screen
 KEY BALANCE	shift the picture to the left or right at the top of the screen

Enlarging or reducing the picture (ZOOM)

This setting is stored in memory for the current input signal.

- 1 Press the joystick.**
The main MENU appears on the screen.
- 2 Move the joystick to highlight  ZOOM and press the joystick again.**
The ZOOM menu appears on the screen.
- 3 Move the joystick left or right to enlarge or reduce the picture.**

Note
Adjustment stops when either the horizontal or vertical size reaches its maximum or minimum value.

Adjusting the color of the picture (COLOR)

The COLOR settings allow you to adjust the picture's color temperature by changing the color level of the white color field. Colors appear reddish if the temperature is low, and bluish if the temperature is high. This adjustment is useful for matching the monitor's colors to a printed picture's colors. This setting is stored in memory for all input signals.

- 1 Press the joystick.**
The main MENU appears on the screen.
- 2 Move the joystick to highlight  COLOR and press the joystick again.**
The COLOR menu appears on the screen.
- 3 Move the joystick left or right to select a color temperature.**
The preset color temperatures are 5000K, 6500K, and 9300K. Since the default setting is 9300K, the whites will change from a bluish hue to a reddish hue as the temperature is lowered to 6500K and 5000K.
- 4 If necessary, fine tune the color temperature.**
First move the joystick up or down to select the desired adjustment item. Then move the joystick left or right to make the adjustment.

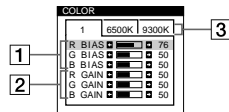

- 1 Adjusting the BIAS (black level)**
This changes the brightness of both the dark and light areas of an image.
- 2 Adjusting the GAIN (white level)**
This changes the contrast of just the light areas of an image.

You can adjust the R(Red), G(Green), and B(Blue) component of the input signal when making changes to items **1** and **2**.







If you fine tune the color temperature, the new color settings are stored in memory for each of the three color temperatures and item **3** of the on-screen menu changes as follows:



- [5000K] → [1]
- [6500K] → [2]
- [9300K] → [3]

Adjusting the quality of the picture (SCREEN)

The SCREEN settings allow you to adjust the quality of the picture by controlling the convergence, moire, and landing.
• If you see red or blue shadows around letters or lines, adjust the convergence.
• If elliptical or wavy patterns appear on the screen, cancel the moire.
• If the color is irregular at the corners of the screen, adjust the landing.
The CANCEL MOIRE and MOIRE ADJUST settings are stored in memory for the current input signal. All other settings are stored in memory for all input signals.

- 1 Press the joystick.**
The main MENU appears on the screen.
- 2 Move the joystick to highlight  SCREEN and press the joystick again.**
The SCREEN menu appears on the screen.
- 3 First move the joystick up or down to select the desired adjustment item. Then move the joystick left or right to make the adjustment.**

Select	To
 H CONVERGENCE	horizontally shift red or blue shadows
 V CONVERGENCE	vertically shift red or blue shadows
 TOP V CONVER TOP	vertically shift red or blue shadows at the top of the screen
 BOT V CONVER BOT	vertically shift red or blue shadows at the bottom of the screen
 LANDING	select one of the four corners of the screen <input type="checkbox"/> :top left <input type="checkbox"/> :top right <input type="checkbox"/> :bottom left <input type="checkbox"/> :bottom right
 ADJ LANDING ADJUST	reduce any irregularities in the color of the corner selected in LANDING to a minimum

Select	To
 CANCEL MOIRE*	turn the moire cancellation function ON or OFF  ADJ (MOIRE ADJUST) appears in the menu when you select ON
 ADJ MOIRE ADJUST	adjust the degree of moire cancellation until the moire is at a minimum

* Moire is a type of natural interference which produces soft, wavy lines on your screen. It may appear due to interference between the pattern of the picture on the screen and the phosphor pitch pattern of the monitor.

Example of moire



Note
The picture may become fuzzy when CANCEL MOIRE is set to ON.

EN

Additional settings (OPTION)

You can manually degauss (demagnetize) the monitor, change the menu position, set the power saving delay time, and lock the controls.

1 Press the joystick.

The main MENU appears on the screen.

2 Move the joystick to highlight OPTION and press the joystick again.

The OPTION menu appears on the screen.

3 Move the joystick to highlight the desired adjustment item.

Adjust the selected item according to the following instructions.

Degaussing the screen



The monitor is automatically demagnetized when the power is turned on.

To manually degauss the monitor, first move the joystick up or down to select  (MANUAL DEGAUSS). Then move the joystick to the right.

The screen is degaussed for about 3 seconds. If a second degauss cycle is needed, allow a minimum interval of 20 minutes for the best result.

Changing the menu's position.

Change the menu's position if it is blocking an image on the screen.

To change the menu's on-screen position, first move the joystick up or down to select  (OSD H POSITION) for horizontal adjustment, or  (OSD V POSITION) for vertical adjustment. Then move the joystick to the left or right to shift the on-screen menu.





Changing the power saving delay time.

To adjust the time it takes to enter the power saving mode, first move the joystick up or down to select  (PWR SAVE DELAY). Then move the joystick to the left or right to select the desired time.

If you select OFF, the monitor does not enter power saving mode. See page 15 for more information about the monitor's power saving capabilities.

Locking the controls.

To protect adjustment data by locking the controls, first move the joystick up or down to select  (CONTROL LOCK). Then move the joystick to the right to select LOCK.

Only the  (power) switch, EXIT, and  (CONTROL LOCK) of the  OPTION menu will operate. If any other items are selected, the  mark appears on the screen.

To cancel the control lock

Repeat the procedure above and set  (CONTROL LOCK) to UNLOCK.

Resetting the adjustments

This monitor has the following three reset methods. Use the RESET button to reset the adjustments.



Resetting a single adjustment item

Use the joystick to select the adjustment item you want to reset, and press the RESET button.

Resetting all of the adjustment data for the current input signal

Press the RESET button when no menu is displayed on the screen. Note that the following items are not reset by this method:

- on-screen menu language (page 8)
- on-screen menu position (page 14)
- power saving delay time (page 14)
- control lock (page 14)

Resetting all of the adjustment data for all input signals

Press and hold the reset button for more than two seconds.

Note

The RESET button does not function when  (CONTROL LOCK) is set to LOCK.

Technical Features

Preset and user modes

When the monitor receives an input signal, it automatically matches the signal to one of the factory preset modes stored in the monitor's memory to provide a high quality picture at the center of the screen. (See page i for a list of the factory preset modes.) For input signals that do not match one of the factory preset modes, the digital Multiscan technology of this monitor ensures that a clear picture appears on the screen for any timing in the monitor's frequency range (horizontal: 30 – 107 kHz (GDM-F400) or 30 – 121 kHz (GDM-F500), vertical: 48 – 160 Hz). If the picture is adjusted, the adjustment data is stored as a user mode and automatically recalled whenever the same input signal is received.

Note for Windows users

For Windows users, check your video board manual or the utility program which comes with your graphic board and select the highest available refresh rate to maximize monitor performance.

Power saving function

This monitor meets the power-saving guidelines set by VESA, ENERGY STAR, and NUTEK. If the monitor is connected to a computer or video graphics board that is DPMS (Display Power Management Signaling) compliant, the monitor will automatically reduce power consumption in three stages as shown below.

Power mode	Power consumption*	 (power) indicator
normal operation	≤ 160 W (GDM-F500) ≤ 140 W (GDM-F400)	green
1 standby	≤ 100 W (GDM-F500) ≤ 80 W (GDM-F400)	green and orange alternate
2 suspend	≤ 15 W (GDM-F500) ≤ 10 W (GDM-F400)	green and orange alternate
3 active off**	≤ 1 W (GDM-F500) ≤ 3 W (GDM-F400)	orange
power off	0 W	off

* Figures reflect power consumption when no USB compatible peripherals are connected to the monitor.

**When your computer enters the "active off" mode, the input signal is cut and NO INPUT SIGNAL appears on the screen. After the time set in "Changing the power saving delay time." (page 14) has elapsed, the monitor enters the power saving mode.

To change the power saving delay time

See page 14.

Troubleshooting

Before contacting technical support, refer to this section.

If thin lines appear on your screen (damper wires)

The lines you are experiencing on your screen are normal for the Trinitron monitor and are not a malfunction. These are shadows from the damper wires used to stabilize the aperture grille and are most noticeable when the screen's background is light (usually white). The aperture grille is the essential element that makes a Trinitron picture tube unique by allowing more light to reach the screen, resulting in a brighter, more detailed picture.

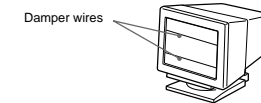

On-screen messages

If there is something wrong with the input signal, one of the following messages appears on the screen. To solve the problem, see "Trouble symptoms and remedies" on page 16.

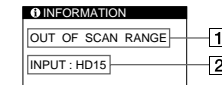

1 The input signal condition

OUT OF SCAN RANGE
indicates that the input signal is not supported by the monitor's specifications.





NO INPUT SIGNAL
indicates that no signal is input, or that no signal is input from the selected connector (HD15 or BNC).

2 The connector indicator

This message indicates which connector is receiving the wrong signal. If there is something wrong with the signal from both connectors, HD15 and BNC are displayed alternately.

Trouble symptoms and remedies

If the problem is caused by the connected computer or other equipment, please refer to the connected equipment's instruction manual. Use the self-diagnosis function (page 18) if the following recommendations do not resolve the problem.

Symptom	Check these items
No picture	
If the  (power) indicator is not lit	<ul style="list-style-type: none"> Check that the power cord is properly connected. Check that the  (power) switch is in the "on" position.
If the NO INPUT SIGNAL message appears on the screen, or if the  (power) indicator is either orange or alternating between green and orange	<ul style="list-style-type: none"> Check that the video signal cable is properly connected and all plugs are firmly seated in their sockets. If you are using the five BNC connectors, connect them in the correct order (from left to right: Red-Green-Blue-HD-VD) (page 6). Check that the input select setting is correct (page 9). Check that the HD15 video input connector's pins are not bent or pushed in. <p>■ Problems caused by the connected computer or other equipment</p> <ul style="list-style-type: none"> The computer is in power saving mode. Try pressing any key on the computer keyboard. Check that the computer's power is "on." Check that the graphic board is completely seated in the proper bus slot.
If the OUT OF SCAN RANGE message appears on the screen	<p>■ Problems caused by the connected computer or other equipment</p> <ul style="list-style-type: none"> Check that the video frequency range is within that specified for the monitor. If you replaced an old monitor with this monitor, reconnect the old monitor and adjust the frequency range to the following. Horizontal: 30 – 107 kHz (GDM-F400), 30 – 121 kHz (GDM-F500) Vertical: 48 – 160 Hz
If no message is displayed and the  (power) indicator is green or flashing orange	<ul style="list-style-type: none"> Use the Self-diagnosis function (page 18).
If using Windows 95/98	<ul style="list-style-type: none"> If you replaced an old monitor with this monitor, reconnect the old monitor and do the following. Install the Windows Monitor Information Disk (page 7) and select this monitor ("GDM-F400" or "GDM-F500") from among the Sony monitors in the Windows 95/98 monitor selection screen. If you choose to select "Plug and Play," connect the monitor to the computer with the HD15 video signal cable. You cannot use the five BNC connectors.
If using a Macintosh system	<ul style="list-style-type: none"> Check that the Macintosh adapter and the video signal cable are properly connected (page 6).
Picture flickers, bounces, oscillates, or is scrambled	<ul style="list-style-type: none"> Isolate and eliminate any potential sources of electric or magnetic fields such as other monitors, laser printers, electric fans, fluorescent lighting, or televisions. Move the monitor away from power lines or place a magnetic shield near the monitor. Try plugging the monitor into a different AC outlet, preferably on a different circuit. Try turning the monitor 90° to the left or right. <p>■ Problems caused by the connected computer or other equipment</p> <ul style="list-style-type: none"> Check your graphics board manual for the proper monitor setting. Confirm that the graphics mode (VESA, Macintosh 21" Color, etc.) and the frequency of the input signal are supported by this monitor (page 1). Even if the frequency is within the proper range, some video boards may have a sync pulse that is too narrow for the monitor to sync correctly. Adjust the computer's refresh rate (vertical frequency) to obtain the best possible picture.
Picture is fuzzy	<ul style="list-style-type: none"> Adjust the brightness and contrast (page 11). Degauss the monitor* (page 14). If CANCEL MOIRE is ON, the picture may become fuzzy. Decrease the moire cancellation effect or set CANCEL MOIRE to OFF (page 13).

Symptom	Check these items
Picture is ghosting	<ul style="list-style-type: none"> Eliminate the use of video cable extensions and/or video switch boxes. Check that all plugs are firmly seated in their sockets.
Picture is not centered or sized properly	<ul style="list-style-type: none"> Press the ASC button (page 9). Adjust the size (page 11) or centering (page 11). Note that some video modes do not fill the screen to the edges.
Edges of the image are curved	<ul style="list-style-type: none"> Adjust the geometry (page 12).
Wavy or elliptical pattern (moire) is visible	<ul style="list-style-type: none"> Cancel the moire (page 13). <p>■ Problems caused by the connected computer or other equipment</p> <ul style="list-style-type: none"> Change your desktop pattern.
Color is not uniform	<ul style="list-style-type: none"> Degauss the monitor* (page 14). If you place equipment that generates a magnetic field, such as a speaker, near the monitor, or if you change the direction the monitor faces, color may lose uniformity. Adjust the landing (page 13).
White does not look white	<ul style="list-style-type: none"> Adjust the color temperature (page 12). Check that the five BNC connectors are connected in the correct order (from left to right: Red-Green-Blue-HD-VD) (page 6).
Letters and lines show red or blue shadows at the edges	<ul style="list-style-type: none"> Adjust the convergence (page 13).
Monitor buttons do not operate	<ul style="list-style-type: none"> If the control lock is set to LOCK, set it to UNLOCK (page 14).
USB peripherals do not function	<ul style="list-style-type: none"> Check that the appropriate USB connectors are securely connected (page 8). Check that the  (power) switch is in the "on" position. <p>■ Problems caused by the connected computer or other equipment</p> <ul style="list-style-type: none"> Check that the power of any self-powered USB compliant peripheral devices is "on." Install the latest version of the device driver on your computer. Contact your device's manufacturer for information about the appropriate device driver. If your USB compliant keyboard or mouse does not function, connect them directly to your computer, reboot your computer, and make any necessary adjustments to the USB settings. Then reconnect the keyboard or mouse to the monitor. For customers using Windows 95 <ol style="list-style-type: none"> Right-click on My Computer and select Properties. Click on the Device Manager tab. Scroll down and select Universal Serial Bus Controller. <ul style="list-style-type: none"> → If Universal Serial Bus Controller does not appear, you need to load a USB supplement disk. Contact your computer's manufacturer for more information about obtaining a USB supplement disk. Select Generic USB Device from the USB controller list and click on Properties. If there is a check in the box next to "Disable in this hardware profile," remove the check. Click on Refresh.
A hum is heard right after the power is turned on	<ul style="list-style-type: none"> This is the sound of the auto-degauss cycle. When the power is turned on, the monitor is automatically degaussed for three seconds.

* If a second degauss cycle is needed, allow a minimum interval of 20 minutes for the best result. A humming noise may be heard, but this is not a malfunction.

Displaying this monitor's name, serial number, and date of manufacture.

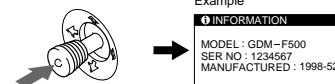

While the monitor is receiving a video signal, press and hold the joystick for more than three seconds to display this monitor's information box.



If the problem persists, call your authorized Sony dealer and give the following information.

- Model name: GDM-F400, GDM-F500
- Serial number
- Name and specifications of your computer and graphics board.

Self-diagnosis function

This monitor is equipped with a self-diagnosis function. If there is a problem with your monitor or computer(s), the screen will go blank and the  (power) indicator will either light up green or flash orange. If the  (power) indicator is lit in orange, the computer is in power saving mode. Try pressing any key on the keyboard.

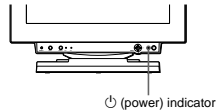

If the (power) indicator is green

- 1 Remove any plugs from the video input 1 and 2 connectors, or turn off the connected computer(s).
- 2 Press the  (power) button to turn the monitor off and on.
- 3 Move the joystick to the right for 2 seconds before the monitor enters power saving mode.





If all four color bars appear (white, red, green, blue), the monitor is working properly. Reconnect the video input cables and check the condition of your computer(s).

If the color bars do not appear, there is a potential monitor failure. Inform your authorized Sony dealer of the monitor's condition.

If the (power) indicator is flashing orange

Press the  (power) button to turn the monitor off and on.

If the  (power) indicator lights up green, the monitor is working properly.

If the  (power) indicator is still flashing, there is a potential monitor failure. Count the number of seconds between orange flashes of the  (power) indicator and inform your authorized Sony dealer of the monitor's condition. Be sure to note the model name and serial number of your monitor. Also note the make and model of your computer and video board.

Specifications

GDM-F400

CRT	0.22 mm aperture grille pitch 19 inches measured diagonally 90-degree deflection FD Trinitron
Viewable image size	Approx. 364.8 × 273.6 mm (w/h) (14 ³ / ₈ × 10 ⁷ / ₈ inches) 18.0" viewing image
Resolution	Horizontal: Max. 1600 dots Vertical: Max. 1200 lines
Standard image area	Approx. 352 × 264 mm (w/h) (13 ⁷ / ₈ × 10 ¹ / ₂ inches) or Approx. 330 × 264 mm (w/h) (13 × 10 ¹ / ₂ inches)
Deflection frequency*	Horizontal: 30 to 107 kHz Vertical: 48 to 160 Hz
AC input voltage/current	100 to 240 V, 50 – 60 Hz, 1.8 – 1.0 A
Power consumption	Max. 140 W (with no USB devices connected)
Dimensions	Approx. 444 × 476 × 455 mm (w/h/d) (17 ¹ / ₂ × 18 ³ / ₄ × 18 inches)
Mass	Approx. 28 kg (61 lb 12 oz)
Plug and Play	DDC1/DDC2B/DDC2B+/DDC2B+
Supplied accessories	See page 6

GDM-F500

CRT	0.22 mm aperture grille pitch 21 inches measured diagonally 90-degree deflection FD Trinitron
Viewable image size	Approx. 403.8 × 302.2 mm (w/h) (16 × 12 inches) 19.8" viewing image
Resolution	Horizontal: Max. 1800 dots Vertical: Max. 1440 lines
Standard image area	Approx. 388 × 291 mm (w/h) (15 ³ / ₈ × 11 ¹ / ₂ inches) or Approx. 364 × 291 mm (w/h) (14 ³ / ₈ × 11 ¹ / ₂ inches)
Deflection frequency*	Horizontal: 30 to 121 kHz Vertical: 48 to 160 Hz
AC input voltage/current	100 to 240 V, 50 – 60 Hz, 2.0 – 1.0 A
Power consumption	Max. 160 W (with no USB devices connected)
Dimensions	Approx. 502 × 511 × 486.3 mm (w/h/d) (19 ⁷ / ₈ × 20 ¹ / ₈ × 19 ¹ / ₄ inches)
Mass	Approx. 34 kg (74 lb 15 oz)
Plug and Play	DDC1/DDC2B/DDC2AB/DDC2B+
Supplied accessories	See page 6

- * Recommended horizontal and vertical timing condition
- Horizontal sync width duty should be more than 4.8% of total horizontal time or 0.8 μs, whichever is larger.
 - Horizontal blanking width should be more than 2.5 μsec.
 - Vertical blanking width should be more than 450 μsec.

Design and specifications are subject to change without notice.

SECTION 2 DISASSEMBLY

2-1. CABINET REMOVAL

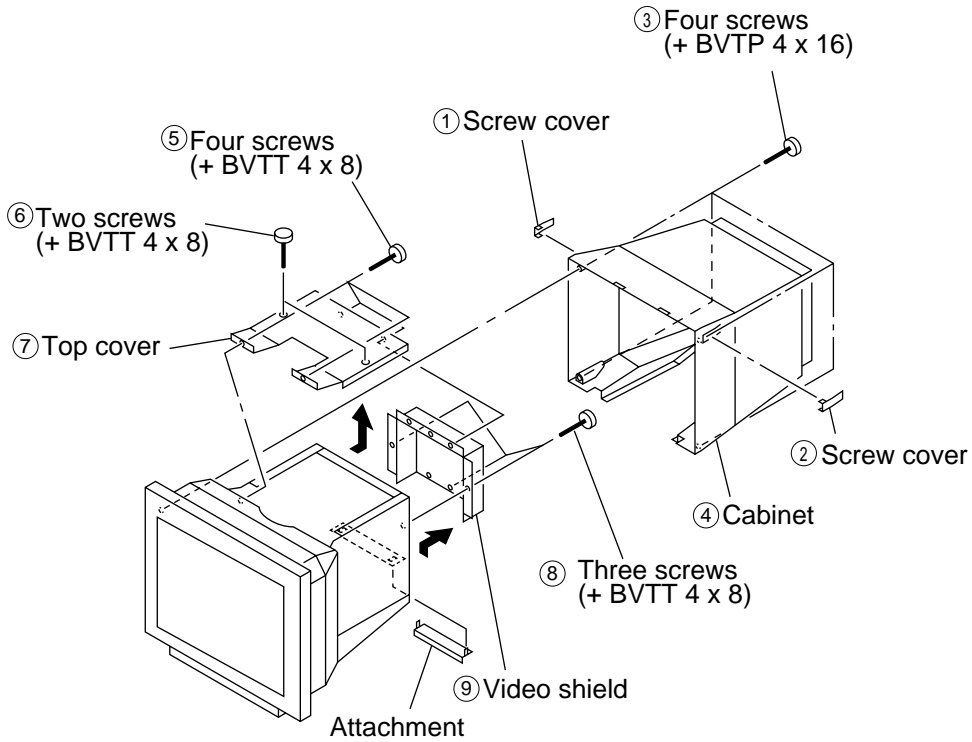

2-2. D BOARD REMOVAL

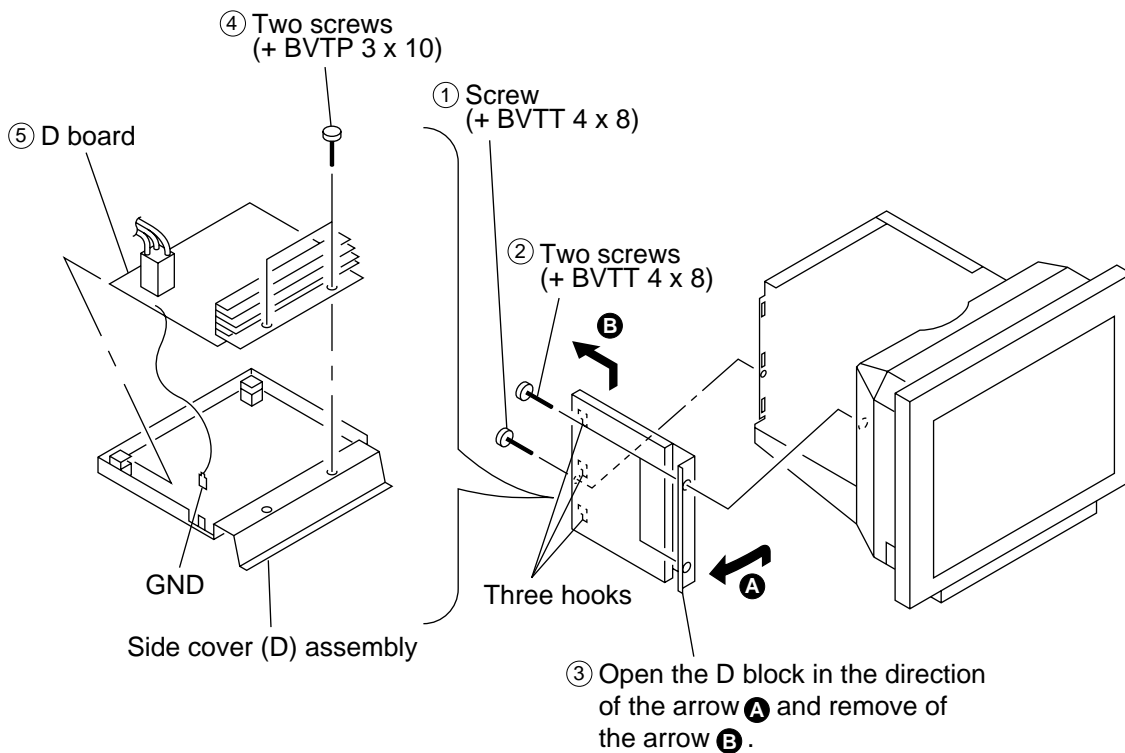

2-3. G BOARD REMOVAL

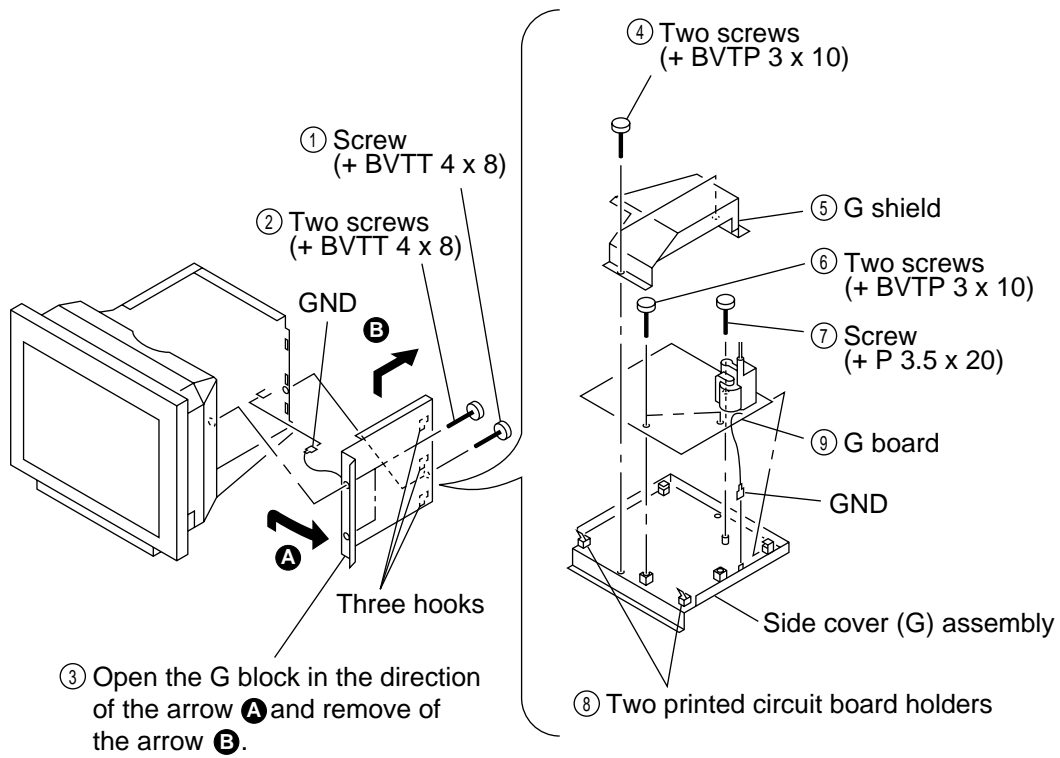

2-4. A BOARD REMOVAL

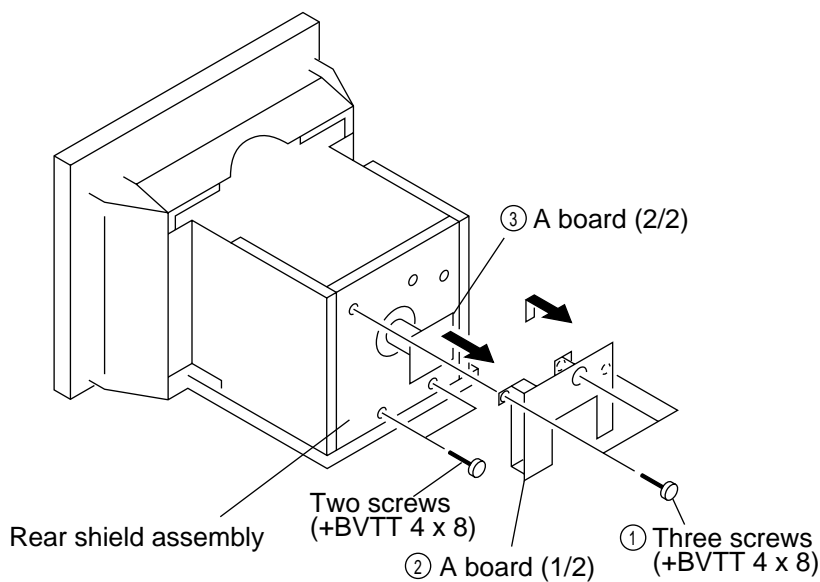

2-5. L BOARD REMOVAL

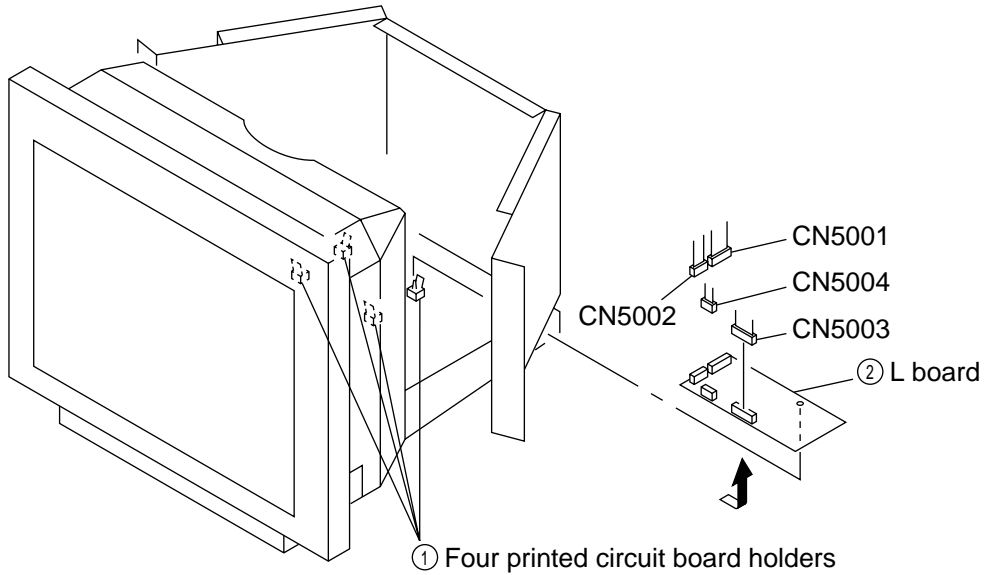

2-6. SERVICE POSITION

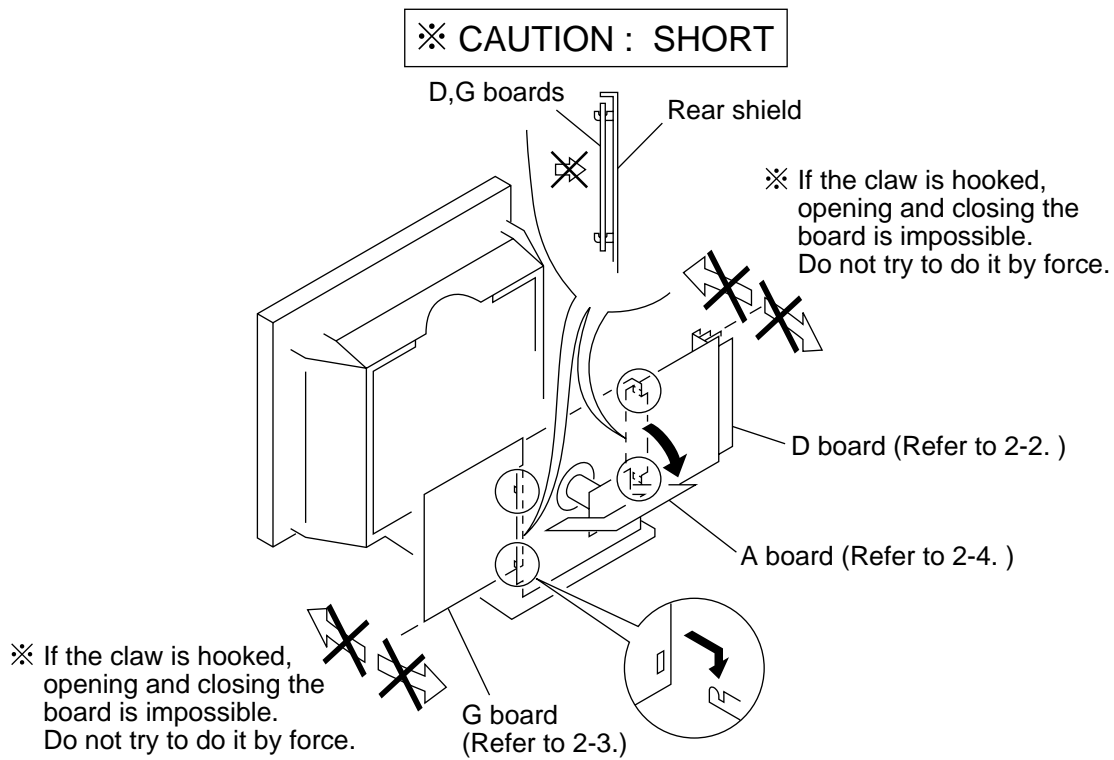

2-7. H1, H2 AND J BOARDS REMOVAL

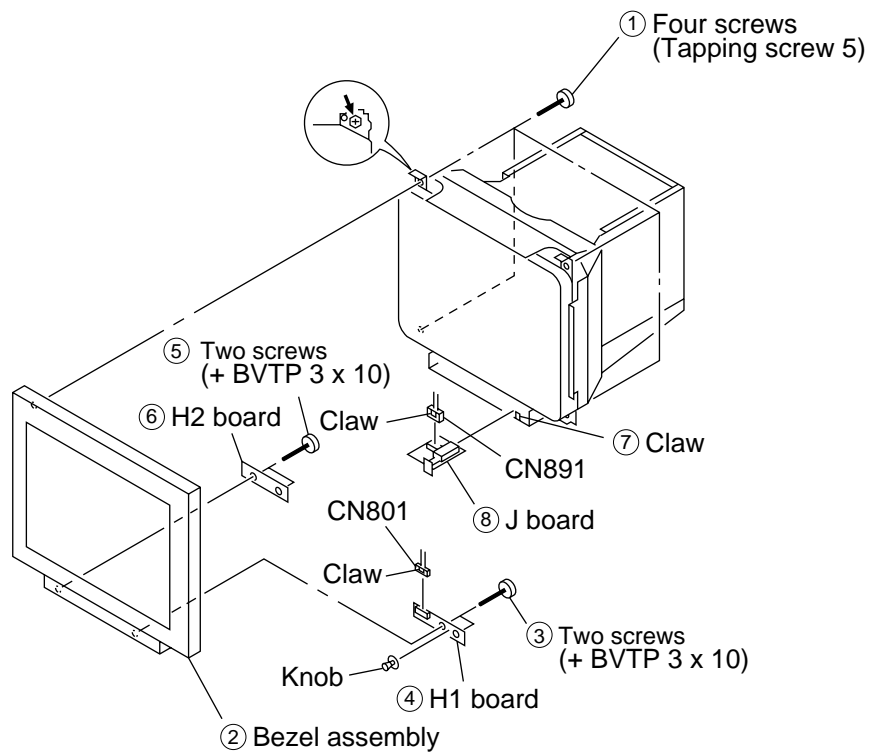

2-8. US BOARD REMOVAL

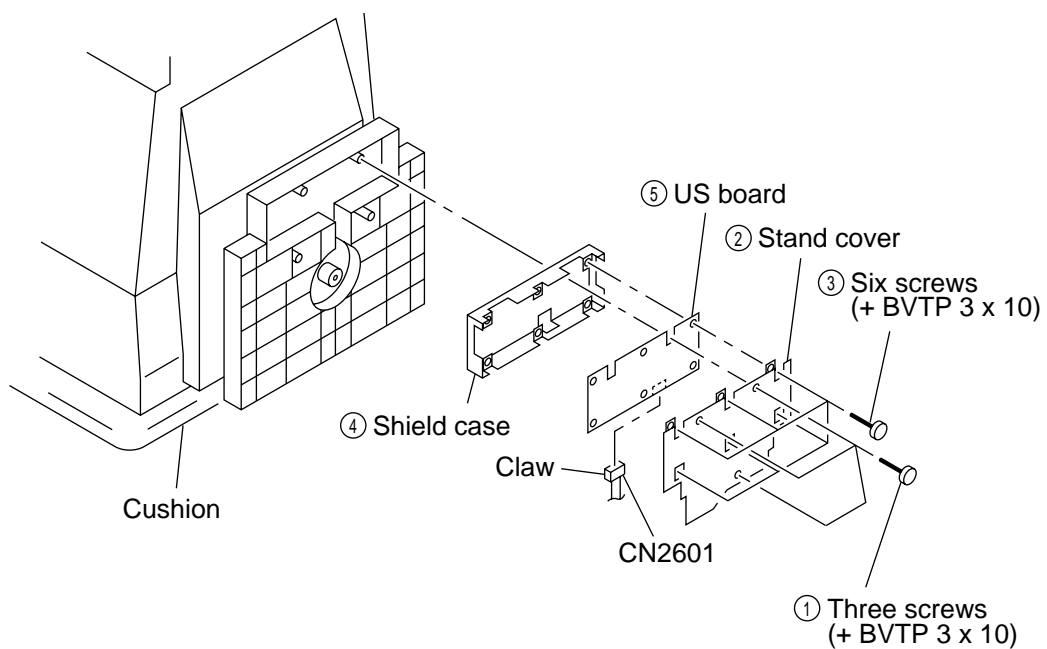

2-9. PICTURE TUBE REMOVAL

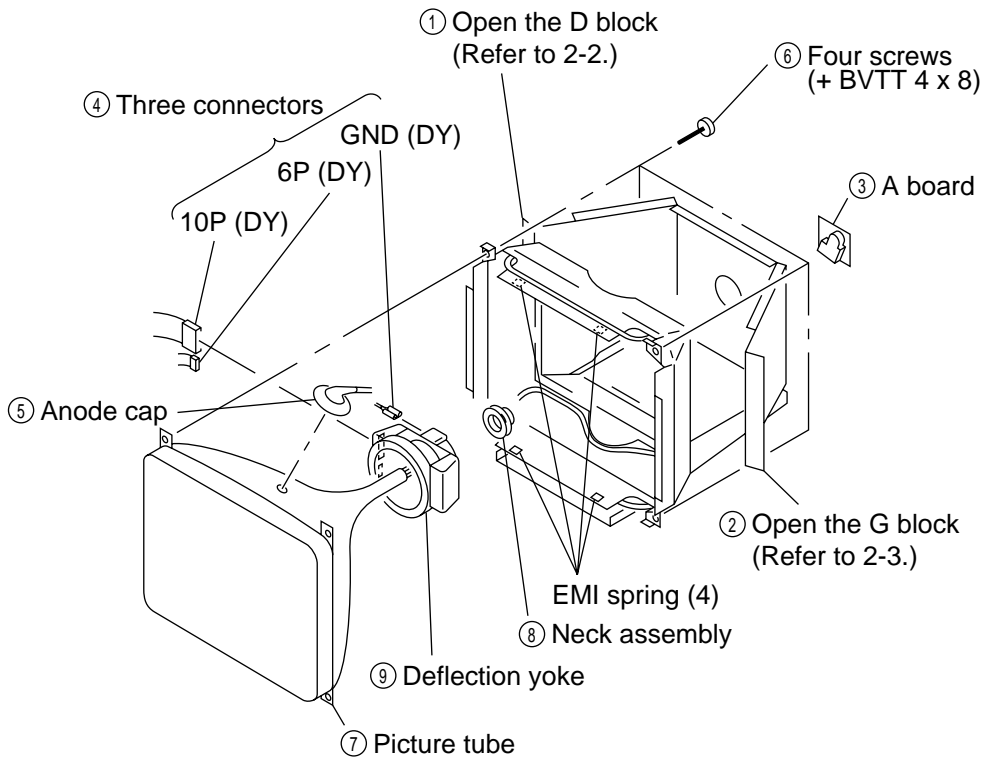

• REMOVAL OF ANODE-CAP

NOTE: Short circuit the anode of the picture tube and the anode cap to the metal chassis, CRT shield or carbon painted on the CRT, after removing the anode.

• REMOVING PROCEDURES

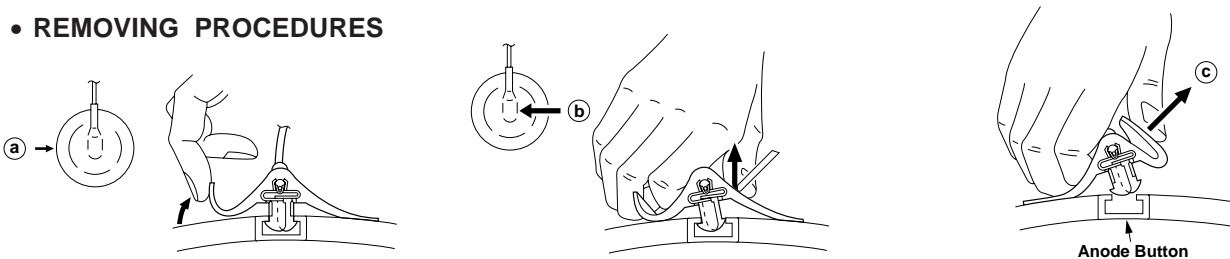

- ① Turn up one side of the rubber cap in the direction indicated by the arrow (a).
- ② Using a thumb pull up the rubber cap firmly in the direction indicated by the arrow (b).
- ③ When one side of the rubber cap is separated from the anode button, the anode-cap can be removed by turning up the rubber cap and pulling up it in the direction of the arrow (c).

• HOW TO HANDLE AN ANODE-CAP

- ① Don't hurt the surface of anode-caps with sharp shaped material!
- ② Don't press the rubber hardly not to hurt inside of anode-caps! A material fitting called as shatter-hook terminal is built in the rubber.
- ③ Don't turn the foot of rubber over hardly! The shatter-hook terminal will stick out or hurt the rubber.

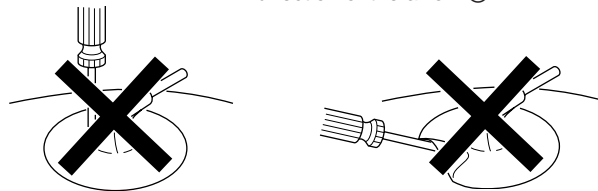

2-10. HARNESS LOCATION

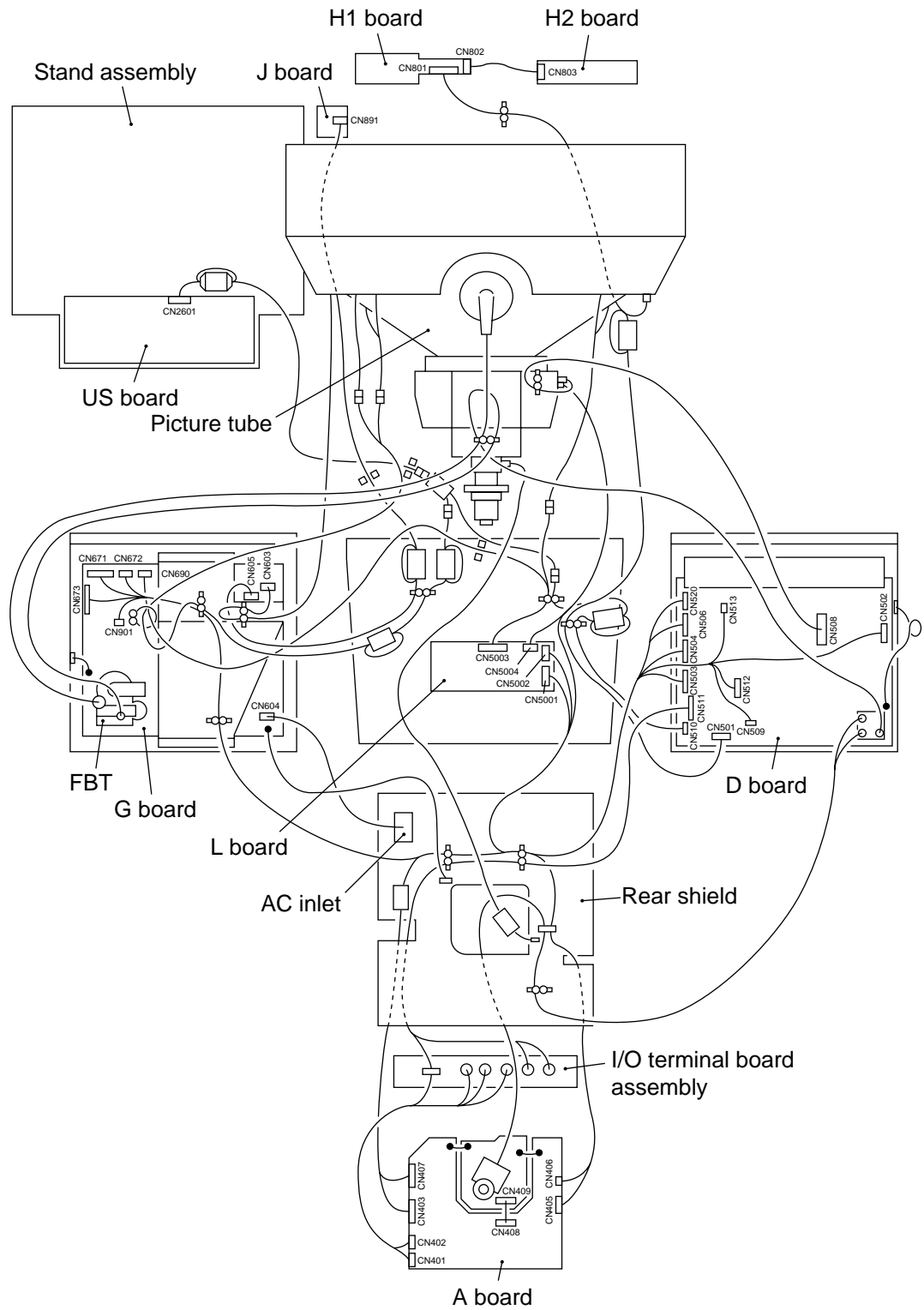

SAFETY RELATED ADJUSTMENT

When replacing or repairing the shown below table, the following operational checks must be performed as a safety precaution against X-rays emissions from the unit.

	Part Replaced (▣)
HV Regulator Circuit Check	G Board IC901, T901 • Mounted G board
HV Protector Circuit Check	G Board Q907, Q908, D913, D916, C923, R920, R927, R952, T901 • Mounted G board
Beam Current Protector Circuit Check	D Board R011, R1068 • Mounted D board G Board IC901, IC902, Q907, Q908, D902, D918, D919, R923, R928, R933, R934, R942, R944, R945, R947, R948, R951, R952, T901 • Mounted G board

* Confirm one minute later turning on the power.

a) B+ Voltage Check

Check Condition

- Input voltage : 100 ~ 240 VAC
- Input signal : White Cross Hatch at 120.7 kHz
- Beam control : BRT and CONT → MAX
- Standard : 200 ± 3.0 V DC

b) HV Regulator Circuit Check

- 1) Confirm that the voltage of the + side of C910 on G board is within the voltage range shown below.
Standard: 8.940 ~ 9.065 V DC

c) HV Protector Circuit Check

- 1) Confirm that the voltage between cathode of D913 on G board and GND is more than 26.5 V DC.
- 2) Confirm that the HV protector circuit works and TV Raster disappears when apply the voltage as shown below between cathode of D913 and GND using an external DC power supply.

Check Condition

- Input voltage : 100 ~ 240 VAC
- Input signal : White Cross Hatch at 120.7 kHz
- Beam control : BRT and CONT → MIN
- Standard : Less than 34.20 V DC

d) Beam Current Protector Circuit Check-1

(Hardware)

Connect a variable resistor (20 kΩ or more) and an ammeter in series between pin ⑪ of T901 (FBT) and -15 V line. Decrease gradually the resistance of the variable resistor from maximum to minimum, and confirm that the Beam Current Protector Circuit works and TV Raster disappears. The current must be within the range shown below.

Check Condition

- Input signal : White Cross Hatch at 120.7 kHz
- Beam control : BRT = 0, CONT = 0
- Standard : 1.49 mA

e) Beam Current Protector Circuit Check-2

(Software)

- 1) Short between + of C937 and GND.
- 2) Connect a variable resistor (20 kΩ or more) and an ammeter in series between pin ⑪ of T901 (FBT) and -15 V line. Decrease gradually the resistance of the variable resistor from maximum to minimum, and confirm that the Beam Current Protector Circuit works and TV Raster disappears. The current must be within the range shown below.

Check Condition

- Input signal : White Cross Hatch at 120.7 kHz
- Beam control : BRT = 0, CONT = 0
- Standard : 1.59 mA

SECTION 4

ADJUSTMENTS

Note: Hand degauss must be used on stand-by or power-off condition.

This model has an automatic earth magnetism correction function by using an earth magnetism sensor and a LCC coil. When using a hand degauss while monitor (LCC coil) is being operated, it sometimes gets magnetized, and the system may not work properly as a result.

• Landing Rough Adjustment

1. Enter the full white signal. (or the full black dots signal).
2. Adjust the contrast to the maximum.
3. Make the screen monogreen.

Note: Off the outputs from R ch and B ch of SG.

4. Reverse the DY, and adjust coarsely the purity magnet so that a green raster positions in the center of screen.
5. Adjust the tilt of DY, and fix lightly with a clamp.

Note: "TILT" shall be set at 128.

• Landing Fine Adjustment

1. Put the set inside the Helmholtz coil. ("LCC SW" = "12")
2. Input the single green signal and set the CONT control to MAX.

Note: After the W/B adjustment with 9300K, measure an average of ΣI_k when a full white signal is entered in the CONT MAX/BRT CENT status. Then make adjustment so that the specified screen can be attained after aging for 2 hours with I_k equivalent to 30% of the average value.

3. Demagnetize the metal part of the chassis with the hand degausser and coil degausser, and the CRT surface with the hand degausser.

Input AC 230V to AC IN, turn on and off the power to perform auto degaussing. (Perform auto degaussing by setting "MON CON REG2"=152. Return to the original value after use.)

Demagnetize the CRT surface with the hand degausser again.

Note:

- (1) Hand degauss must be used on stand-by or power-off condition.

This model has an automatic earth magnetism correction function by using an earth magnetism sensor and a LCC coil. When using a hand degauss while monitor (LCC coil) is being operated, it sometimes gets magnetized, and the system may not work properly as a result.

- (2) Adjust in a non-magnetic field. $BV=45uT$.
- (3) If adjusting in a magnetic fields, add the shift from the non-magnetic field in your estimation.
4. Attach the wobbling coil to the designated part of the CRT neck.
5. Attach the sensor of the landing adjustment unit on the CRT surface.
6. Adjust the DY position and purity, and the DY tilt, and landing of the center and 4 corners with the landing checker.

- Write terrestrial magnetism sensor reading VX and VY to "LCC VX" and "LCC VY" respectively. Adjust the landing by moving "LCC NS", "LCC LT", "LCC LB", "LCC RT" and "LCC RB". However, the register adjustment must be limited within the following range.

"LCC NS" 128 ± 15

"LCC LT", "LCC LB", "LCC RT", "LCC RB"

128 ± 40

After adjustment, set "LCC SW" to "13" and save the service data.

<Specifications>

Adjust so that the green is within the specification given right.
Adjust target : within ± 1

_____ (μm)		
0 ± 3	0 ± 7.5	0 ± 3
0 ± 5	0 ± 5	0 ± 5
0 ± 3	0 ± 7.5	0 ± 3

The red and blue must be within the specification given right with respect to the green.

_____ (μm)		
± 6	± 6	± 6
± 6	± 4	± 6
± 6	± 6	± 6

A difference between red and blue must be within the specification given right.

_____ (μm)		
10	10	10
10	7	10
10	10	10

* Adjustment and measurement should be made at the points one inch inside the fluorescent screen.

7. Insert wedges to make the DY neck stand upright without moving it.

At this time, without shaking the DY, firmly insert the wedges.

8. Check the landing of each corner, and if it does not satisfy the specification, adjust the landing of four corners using "LCC LT", "LCC LB", "LCC RT" and "LCC RB".

However, the register adjustment must be limited within the following range.

"LCC NS" 128 ± 15

"LCC LT", "LCC LB", "LCC RT", "LCC RB"

128 ± 40

After adjustment, save the service data.

If it does not yet satisfy the specification, paste a Disk-Mg onto the funnel and adjust.

Note:

- (1) Do not paste more than two magnets on one corner.
- (2) Magnets will be placed in a range 80 ~ 100 mm from the DY along diagonal lines.
- (3) After placing magnets, absolutely hand degauss and check the results. (Hand degauss must be used on stand-by or power-off condition.)
9. Remove the sensor and wobbling coil.
10. Switch the signal to R.G.B., and check that each color is pure.
11. Check that the DY is not tilting, and fix the purity Mg with a white pen.

Connect the communication cable of the computer to the connector located on the D board or US board on the monitor. Run the service software and then follow the instruction.

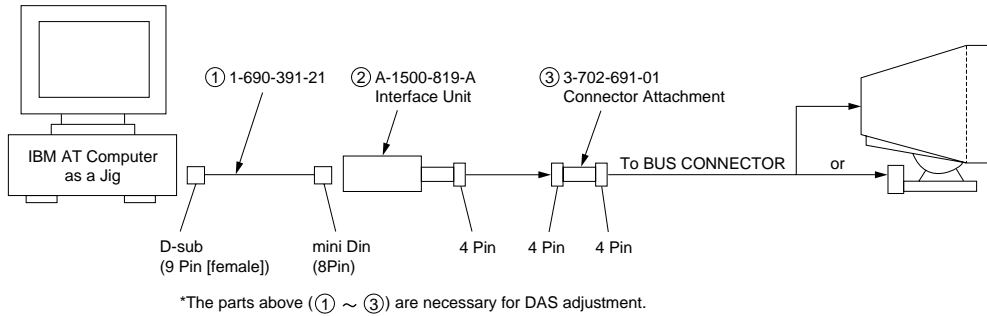

• Convergence Rough Adjustment

- (1) Receive an image of the white crosshatch signals (white lines on black).
- (2) Place the protrusions of the 6-fold poles magnet attached to the CRT neck upon each other. (Fig. 1)
- (3) Make rough adjustment of the H and V direction convergence by using 4-fold poles magnet.

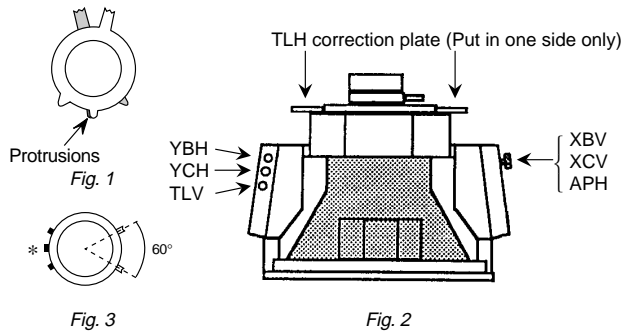

• Convergence Specification

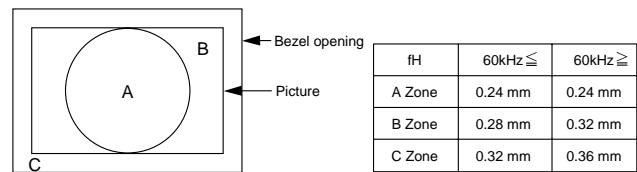

• White Balance Adjustment Specification

- 9300K
 $x=0.283 \pm 0.005$
 $y=0.298 \pm 0.005$
 (All White)
- 6500K
 $x=0.313 \pm 0.005$
 $y=0.329 \pm 0.005$
 (All White)
- 5000K
 $x=0.346 \pm 0.005$
 $y=0.359 \pm 0.005$
 (All White)

• Vertical and Horizontal Position and Size Specification

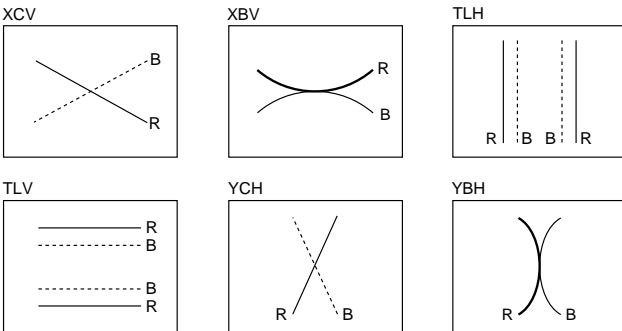
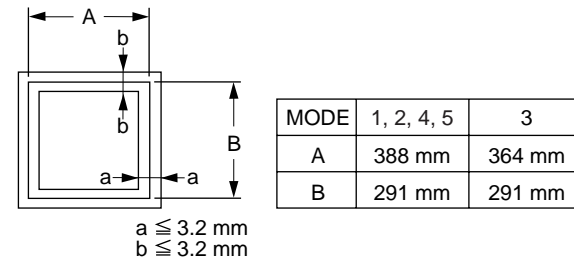

• Focus adjustment

Adjust the focus volume 1 and 2 for the optimum focus.

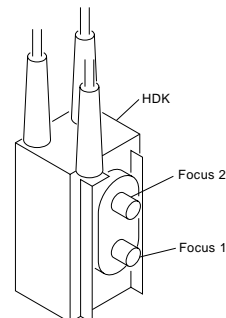

SECTION 5 DIAGRAMS

5-1. BLOCK DIAGRAMS

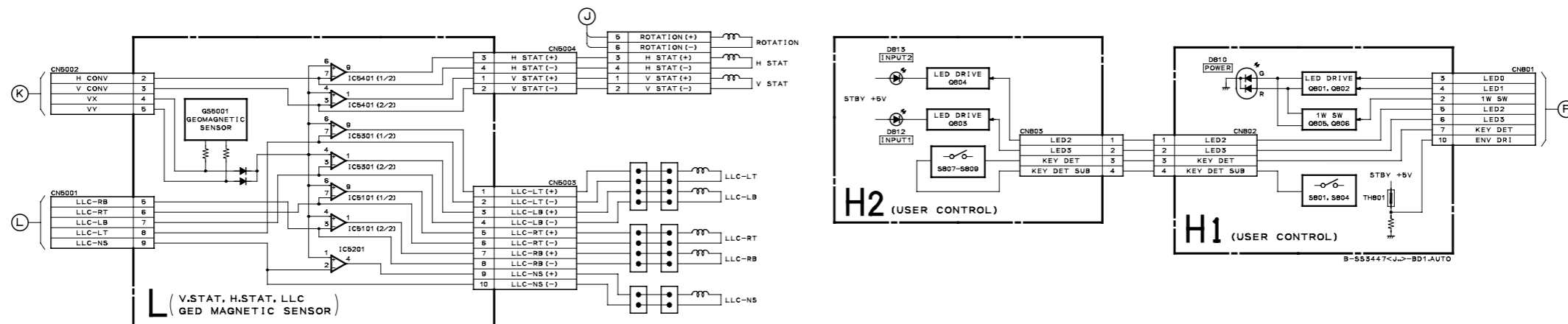
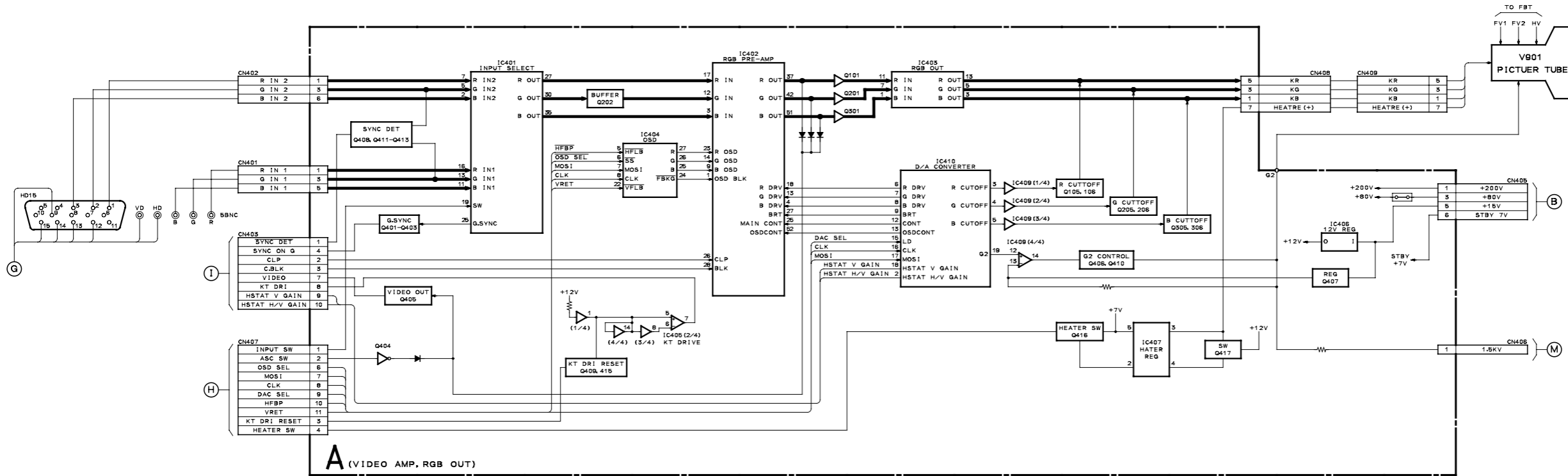

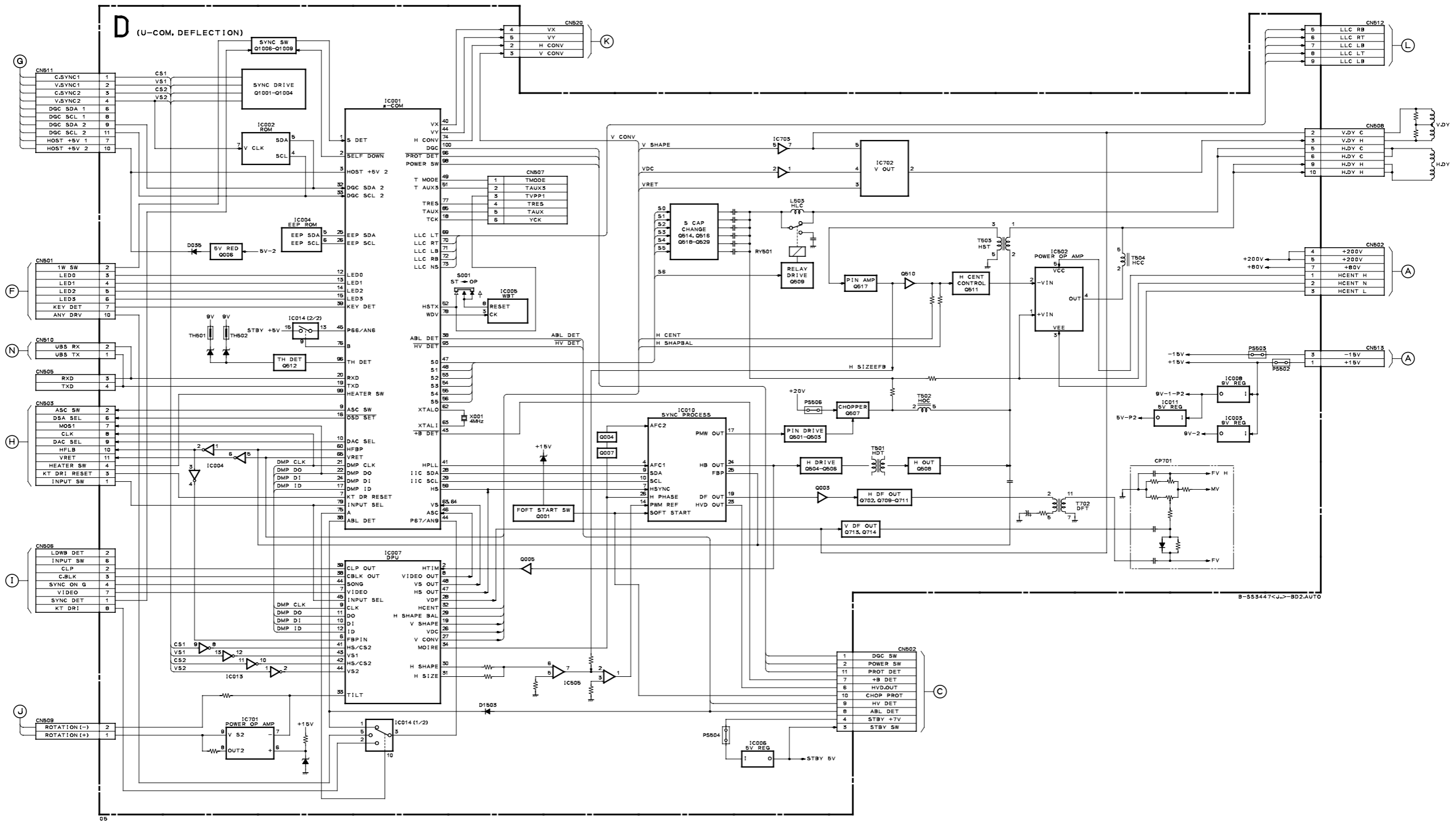

OLD MODEL
 (F500 (U/C) : S/N 2 700,001 to 2 701,030)
 (F500 (AEP) : S/N 2 800,001 to 2 801,280)

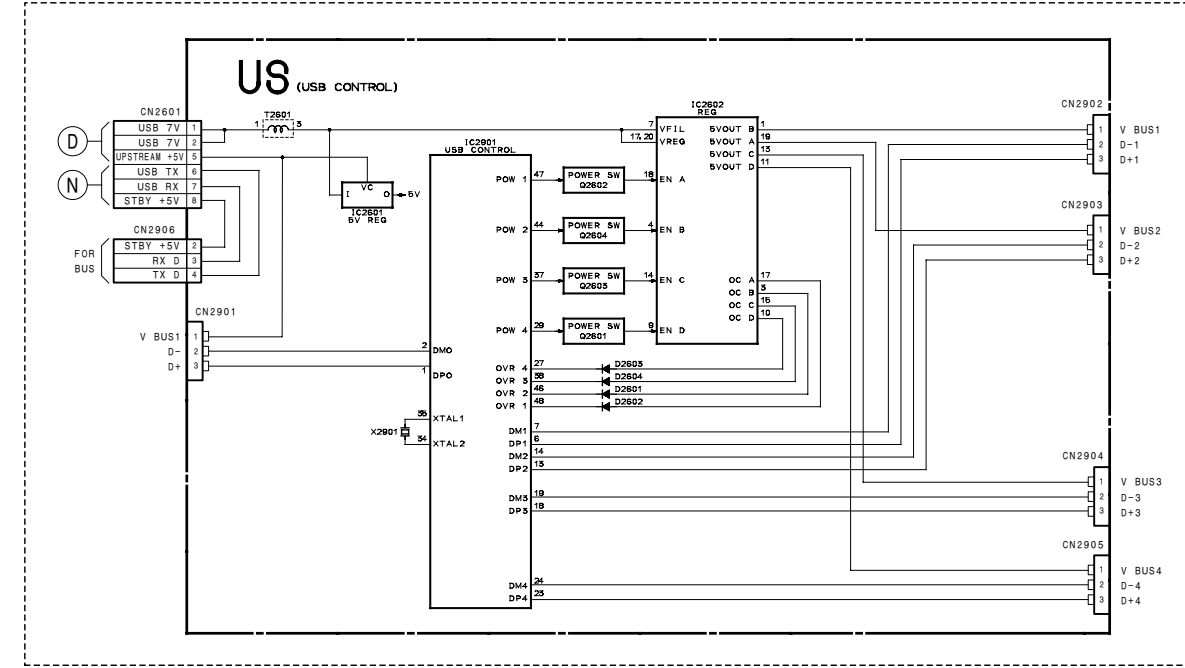

NEW MODEL
 (F500 (U/C) : S/N 2 701,031 and later)
 (F500 (AEP) : S/N 2 801,281 and later)
 F500T9 : All units

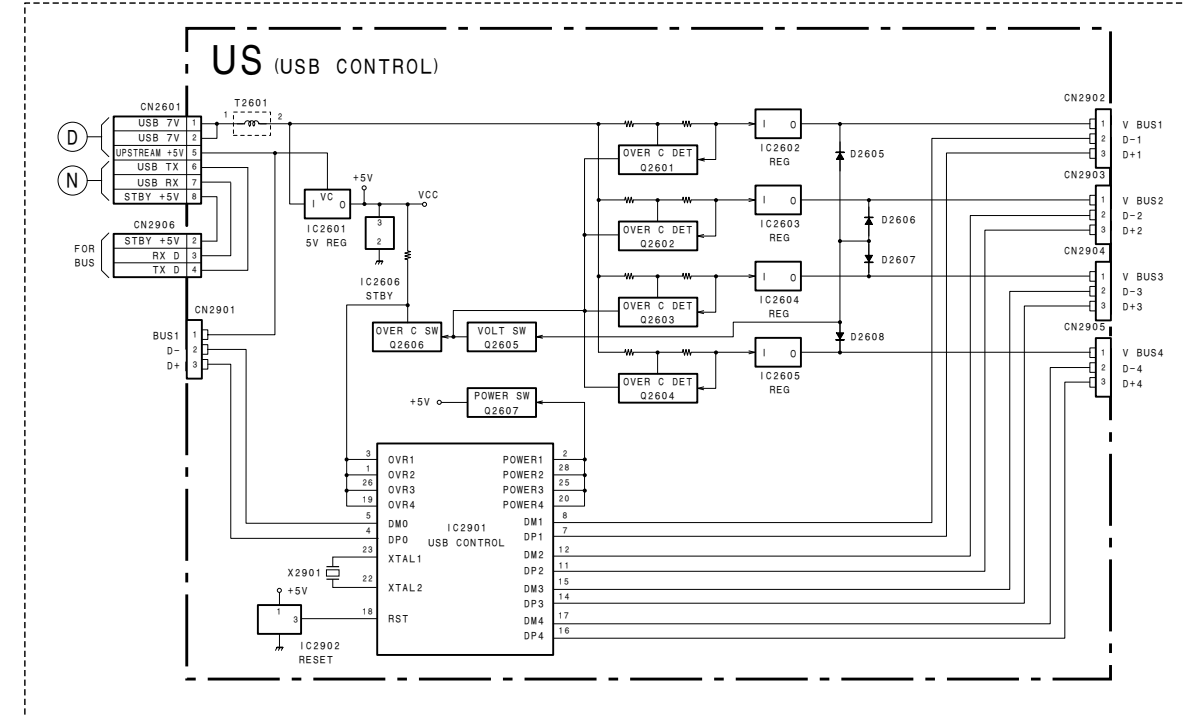

5-2. FRAME SCHEMATIC DIAGRAM

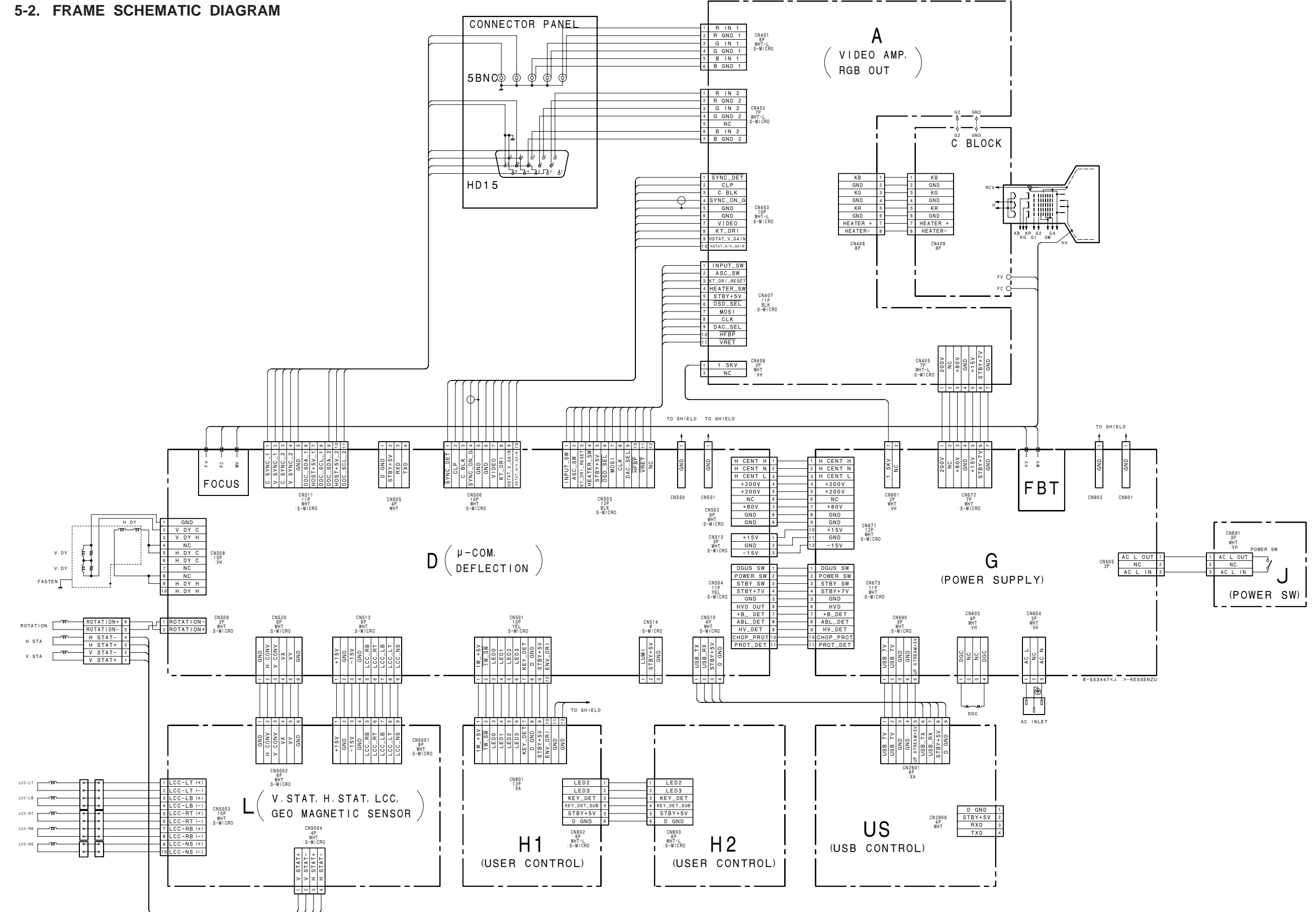
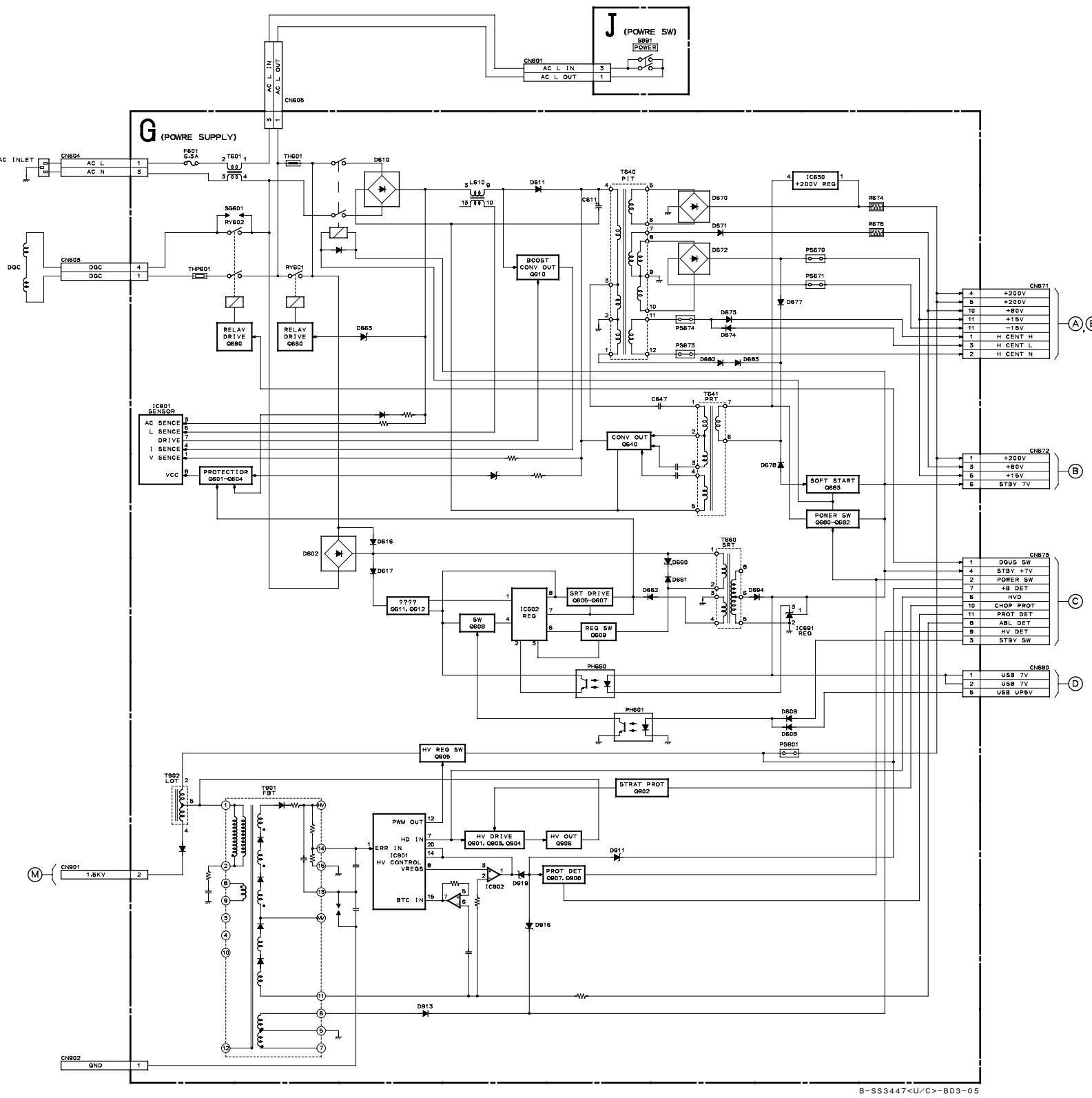

5-3. CIRCUIT BOARDS LOCATION

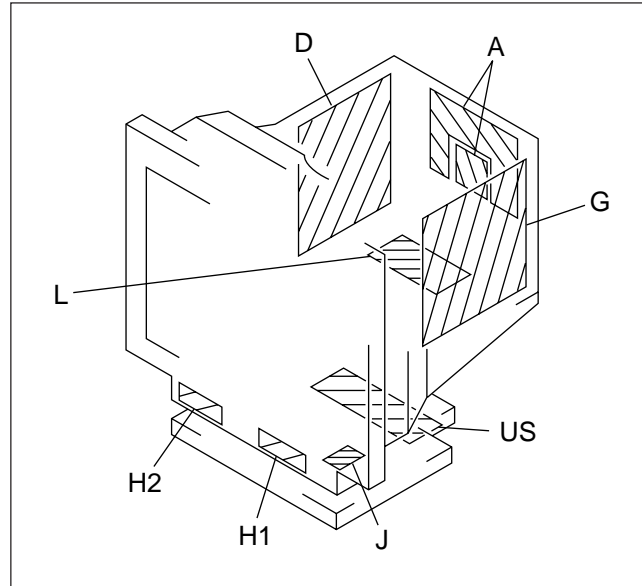

Note: The components identified by shading and mark **△** are critical for safety. Replace only with part number specified.

Note: Les composants identifiés par un trame et une marque **△** sont critiques pour la sécurité. Ne les remplacer que par une pièce portant le numéro spécifié.

- All voltages are in V.
- Readings are taken with a 10 M digital multimeter.
- Readings are taken with a color-bar signal input.
- Voltage variations may be noted due to normal production tolerances.
- * : Can not be measured.
- Circled numbers are waveform references.
- — : B + bus.
- - - - : B - bus.

5-4. SCHEMATIC DIAGRAMS AND PRINTED WIRING BOARDS

Note:

- All capacitors are in μF unless otherwise noted. (pF : μpF) Capacitors without voltage indication are all 50 V.
- Indication of resistance, which does not have one for rating electrical power, is as follows.

Pitch: 5 mm
Rating electrical power 1/4 W (CHIP: 1/10 W)

- All resistors are in ohms.
- : nonflammable resistor.
- : fusible resistor.
- Δ : internal component.
- : panel designation, and adjustment for repair.
- All variable and adjustable resistors have characteristic curve B, unless otherwise noted.
- \perp : earth-ground.
- /// : earth-chassis.

- The components identified by **■** in this basic schematic diagram have been carefully factory-selected for each set in order to satisfy regulations regarding X-ray radiation.
- Should replacement be required, replace only with the value originally used.
- When replacing components identified by **■**, make the necessary adjustments indicated. (See page 3-1.)
- When replacing the part in below table, be sure to perform the related adjustment.

	Part Replaced (\blacktriangle)
HV Regulator Circuit Check	G Board IC901, T901 • Mounted G board
HV Protector Circuit Check	G Board Q907, Q908, D913, D916, C923, R920, R927, R952, T901 • Mounted G board
Beam Current Protector Circuit Check	D Board R011, R1068 • Mounted D board G Board IC901, IC902, Q907, Q908, D902, D918, D919, R923, R928, R933, R934, R942, R944, R945, R947, R948, R951, R952, T901 • Mounted D board

Terminal name of semiconductors in silk screen printed circuit (*)

Device	Printed symbol	Terminal name	Circuit
① Transistor		Collector Base Emitter	
② Transistor		Collector Base Emitter	
③ Diode		Cathode Anode	
④ Diode		Cathode Anode (NC)	
⑤ Diode		Cathode Anode (NC)	
⑥ Diode		Common Anode Cathode	
⑦ Diode		Common Anode Cathode	
⑧ Diode		Common Anode Anode	
⑨ Diode		Common Anode Anode	
⑩ Diode		Common Cathode Cathode	
⑪ Diode		Common Cathode Cathode	
⑫ Diode		Anode Anode Cathode Cathode	
⑬ Transistor (FET)		Drain Source Gate	
⑭ Transistor (FET)		Drain Source Gate	
⑮ Transistor (FET)		Source Drain Gate	
⑯ Transistor		Emitter Collector Base	
- Discrete semiconductor			

(Chip semiconductors that are not actually used are included.)

D BOARD (Conductor Side)

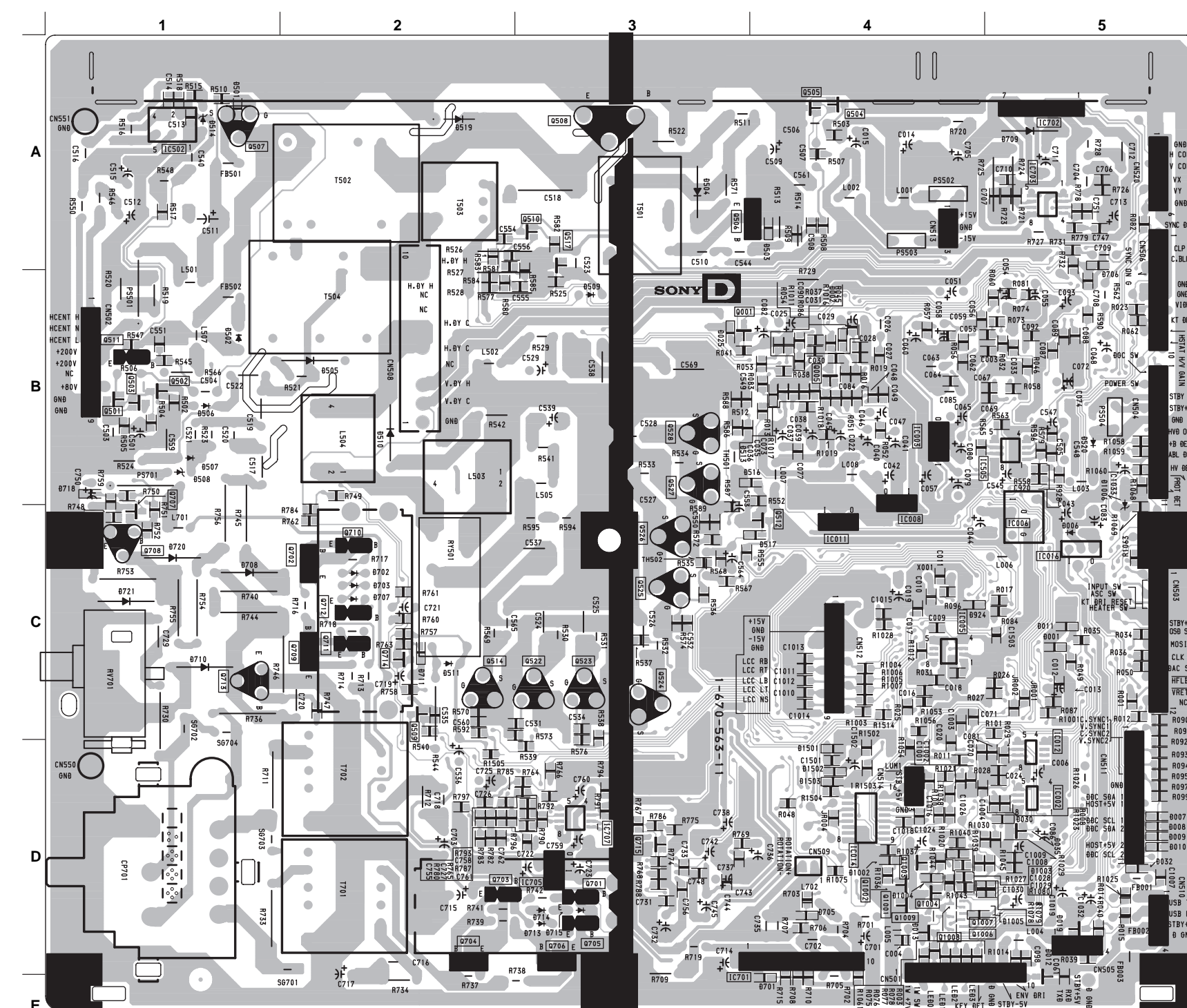

NOTE:
The circuit indicated as left contains high voltage of over 600 Vp-p. Care must be paid to prevent an electric shock in inspection or repairing.

D BOARD SEMICONDUCTOR LOCATION

IC	(Conductor Side)	(Component Side)	
IC001	D-5	C-1	①
IC002	D-5	C-1	②
IC003	B-4	B-2	③
IC004	C-4	C-1	④
IC005	C-4	C-1	⑤
IC006	C-5	C-1	⑥
IC007	B-1	B-1	⑦
IC008	C-4	C-2	⑧
IC010	B-2	B-2	⑨
IC011	C-4	C-2	⑩
IC013	B-1	B-1	⑪
IC014	D-4	D-5	⑫
IC016	C-5	C-5	⑬
IC502	A-1	A-5	⑭
IC505	B-4	B-3	⑮
IC701	E-2	E-2	⑯
IC702	A-5	A-1	⑰
IC703	A-5	A-5	⑱
IC1004	D-1	D-1	⑲
DIODE			
(Conductor Side) (Component Side) *			
D004	D-1	D-1	①
D006	C-5	C-5	②
D012	D-5	D-5	③
D013	D-4	D-4	④
D014	D-2	D-2	⑤
D015	D-2	D-2	⑥
D016	D-1	D-1	⑦
D019	D-5	D-5	⑧
D020	D-1	D-1	⑨
D025	B-3	B-3	⑩
D026	C-1	C-1	⑪
D027	C-1	C-1	⑫
D028	D-1	D-1	⑬
D029	D-1	D-1	⑭
D032	D-1	D-1	⑮
D035	D-5	D-5	⑯
D050	B-1	B-1	⑰
D501	A-1	A-1	⑱
D502	B-2	B-2	⑲
D503	A-4	A-4	⑳
D504	A-3	A-3	㉑
D505	B-2	B-2	㉒
D506	B-1	B-4	㉓
D507	B-1	B-5	㉔
D508	B-1	B-5	㉕
D509	B-3	B-3	㉖
D510	B-2	B-4	㉗
D511	C-2	C-4	㉘
D513	B-3	B-3	㉙
D514	A-1	A-5	㉚
D516	B-3	B-3	㉛
D517	C-4	C-4	㉜
D518	B-4	B-4	㉝
D519	A-2	A-4	㉞
D521	B-5	B-5	㉟
D701	E-4	E-4	①
D702	C-2	C-4	②
D703	C-2	C-4	③
D704	D-3	D-3	④
D705	D-4	D-4	⑤
D706	B-5	B-5	⑥
D707	C-2	C-4	⑦
D708	A-5	C-5	⑧
D709	A-1	A-5	⑨
D710	C-1	C-1	⑩
D711	C-2	D-1	⑪
D921	C-3	C-3	⑫
D924	C-4	D-2	⑬
D1001	D-4	D-2	⑭
D1002	D-4	D-4	⑮
D1003	D-4	D-4	⑯
D1004	D-4	D-4	⑰
D1005	D-5	D-5	⑱
D1006	C-4	C-1	⑲
D1007	C-4	D-1	⑳
D1501	D-4	D-4	㉑
D1502	D-4	D-4	㉒
D1503	D-4	D-4	㉓
CRYSTAL			
(Conductor Side) (Component Side)			
X001	C-4	C-2	①

*: Refer to Terminal name of semiconductors in silk screen printed circuit (see page 5-9)

D BOARD (Component Side)

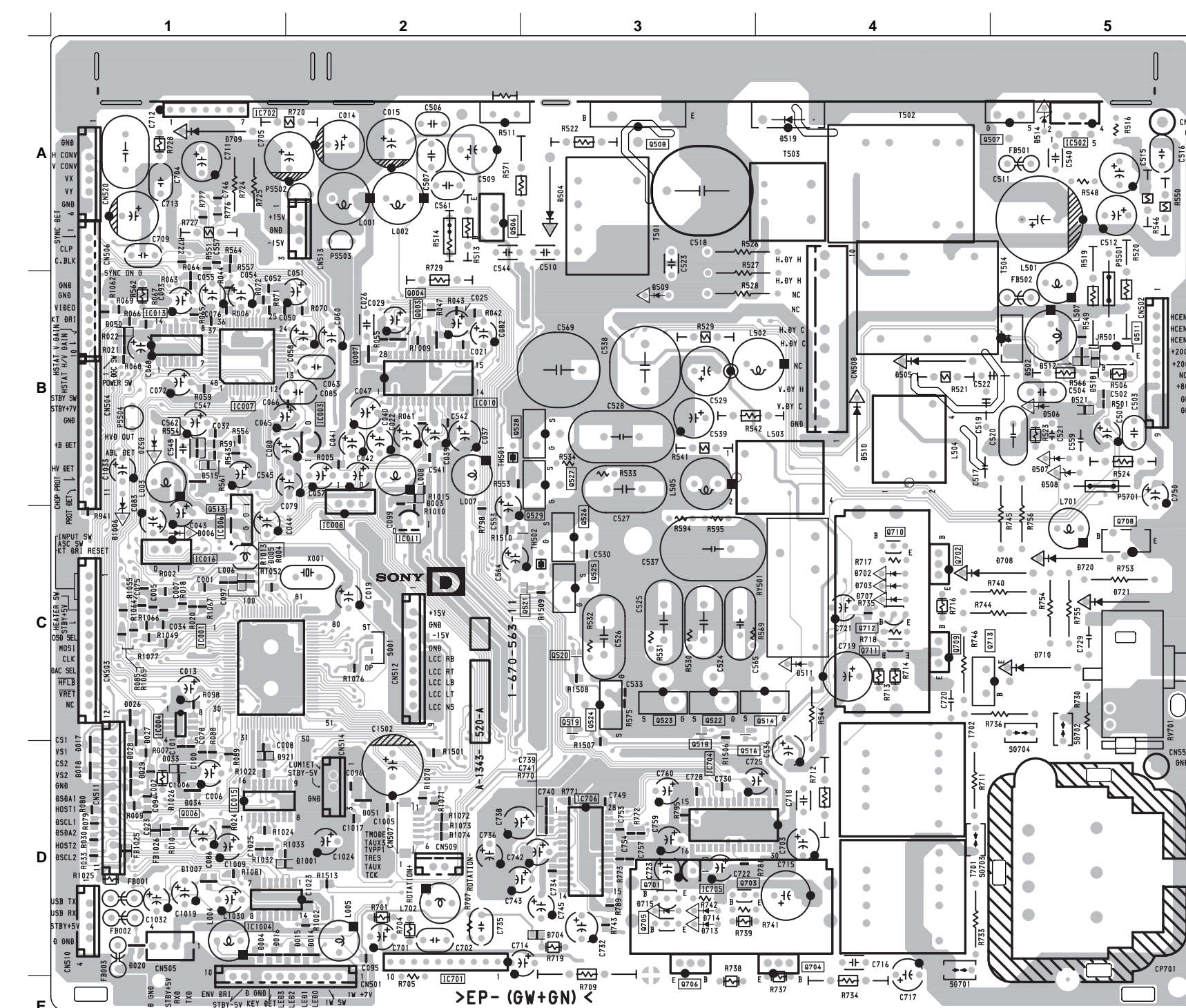

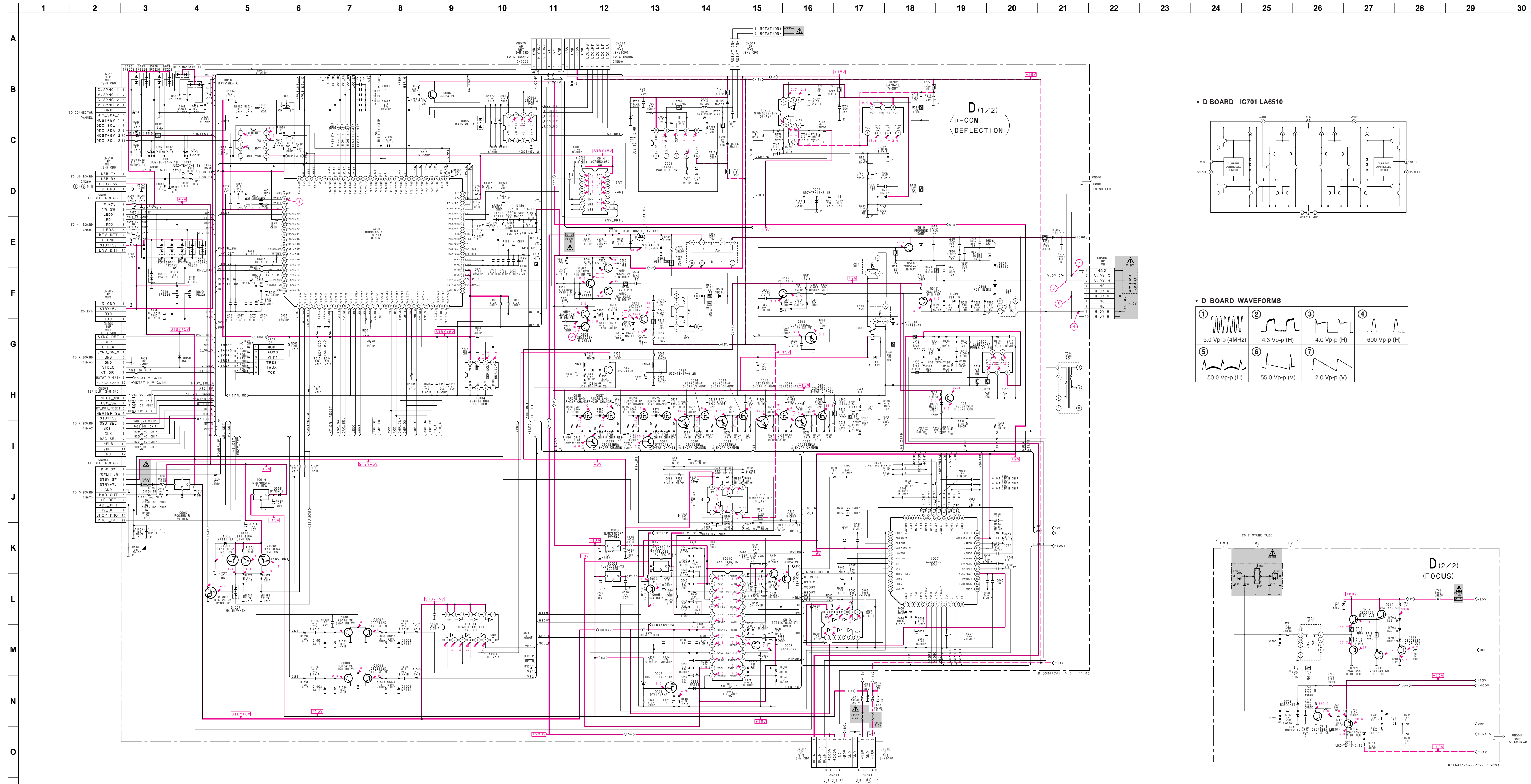

• D BOARD IC701 LA6510

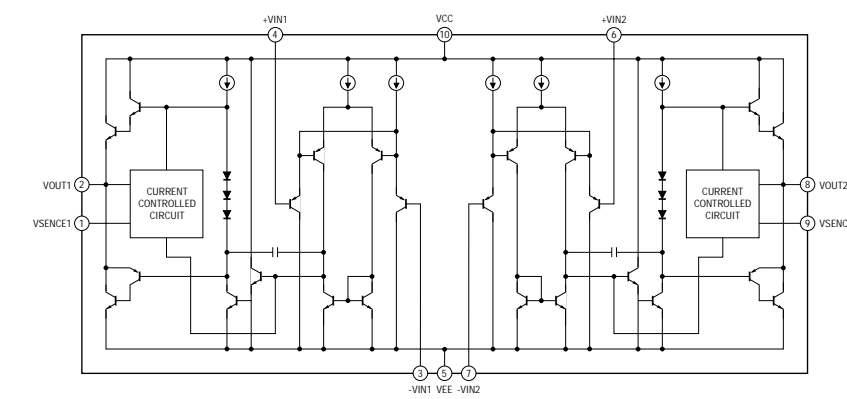

• D BOARD WAVEFORMS

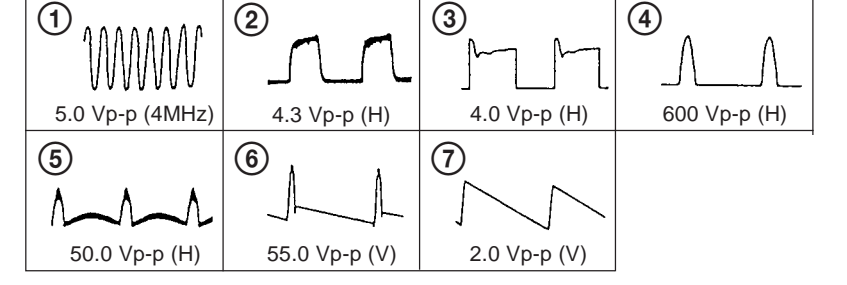

D (2/2) (FOCUS)

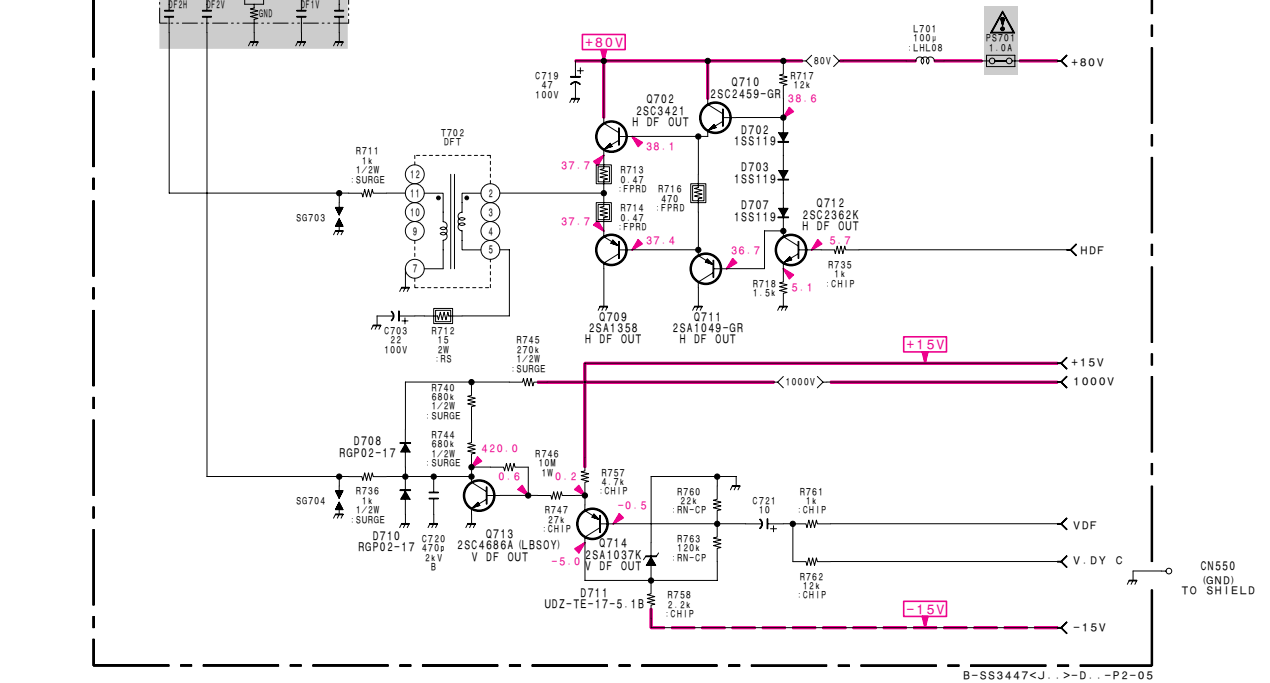

1 2 3 4 5 6 7 8 9 10 11 12 13 14 15 16 17 18 19 20 21 22 23 24 25 26 27 28 29 30

A
B
C
D
E
F
G
H
I
J
K
L
M
N
O

A
B
C
D
E
F
G
H
I
J
K
L
M
N
O

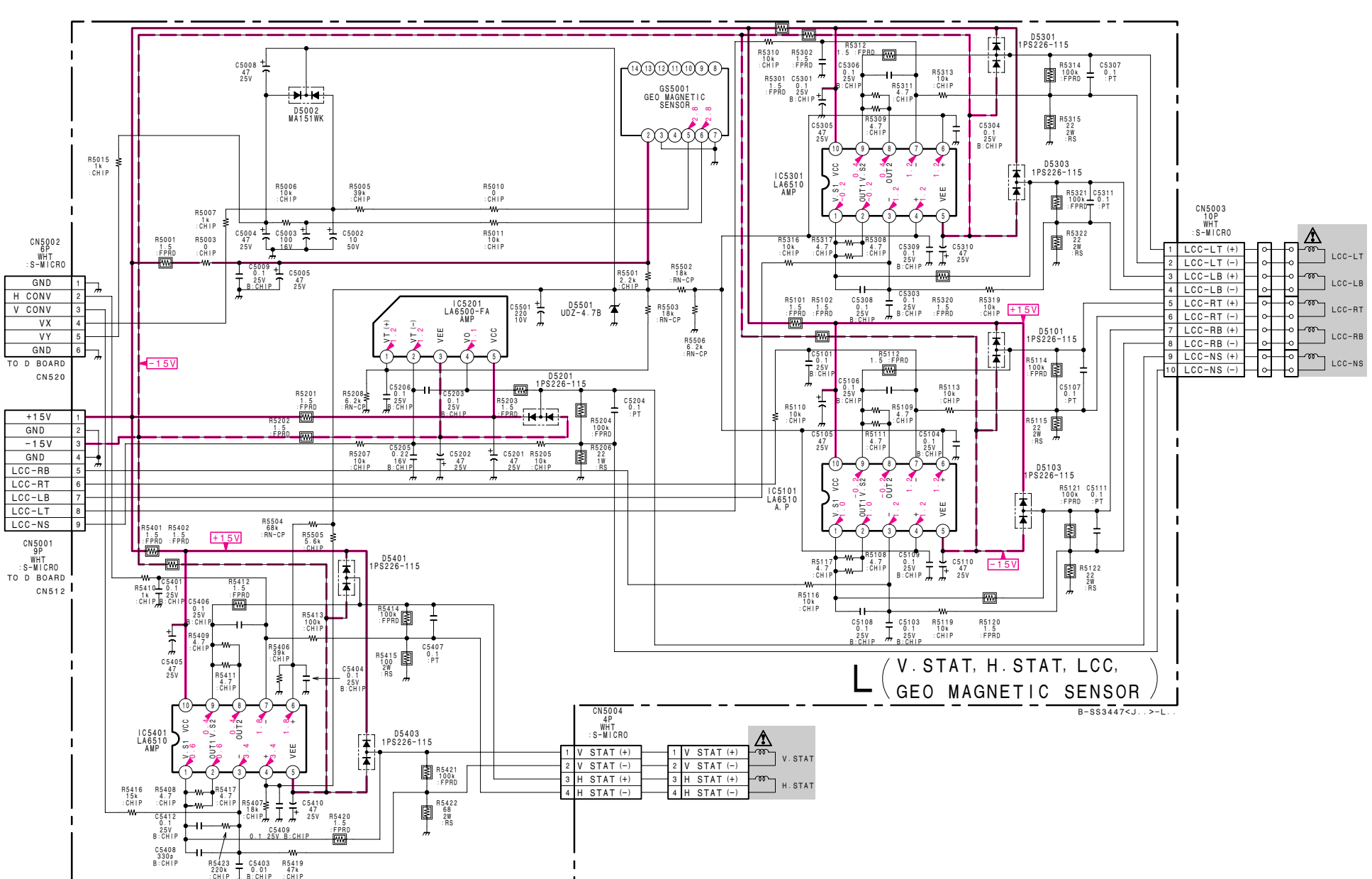
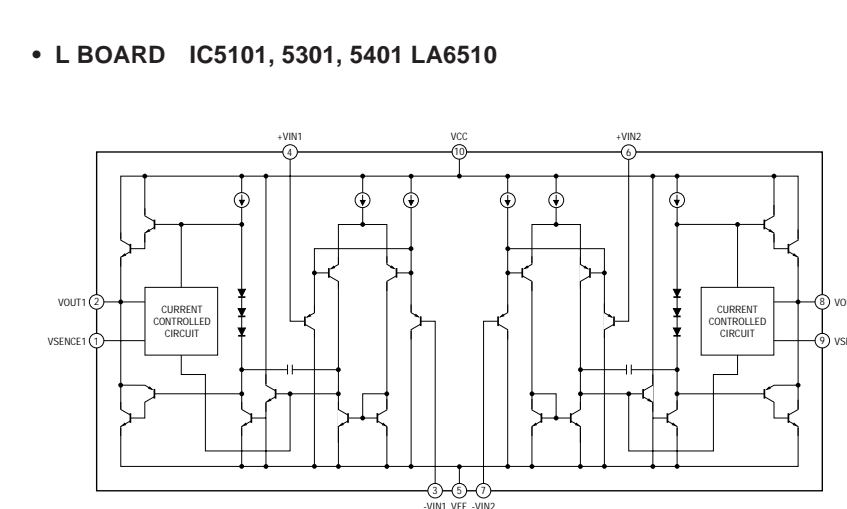
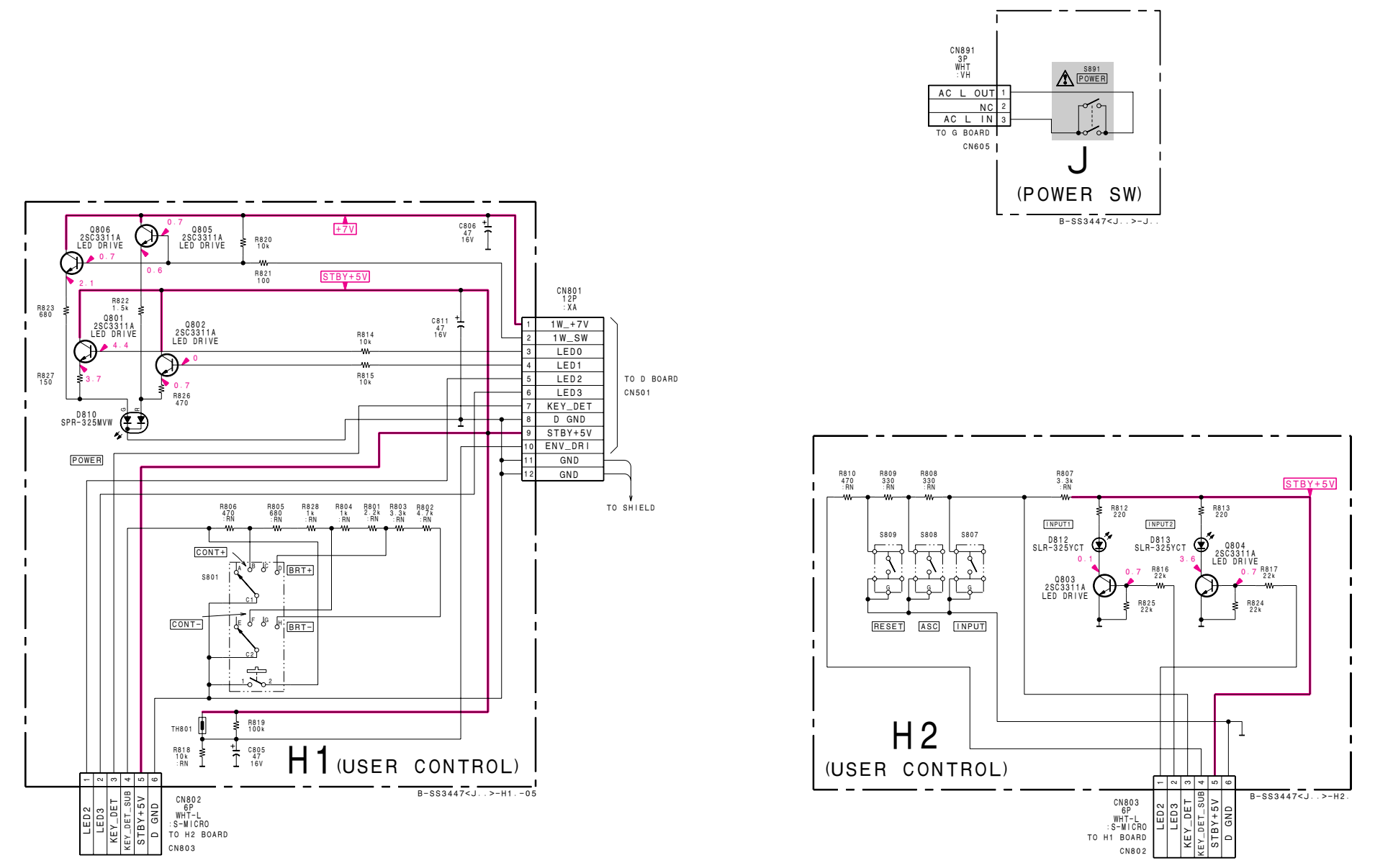
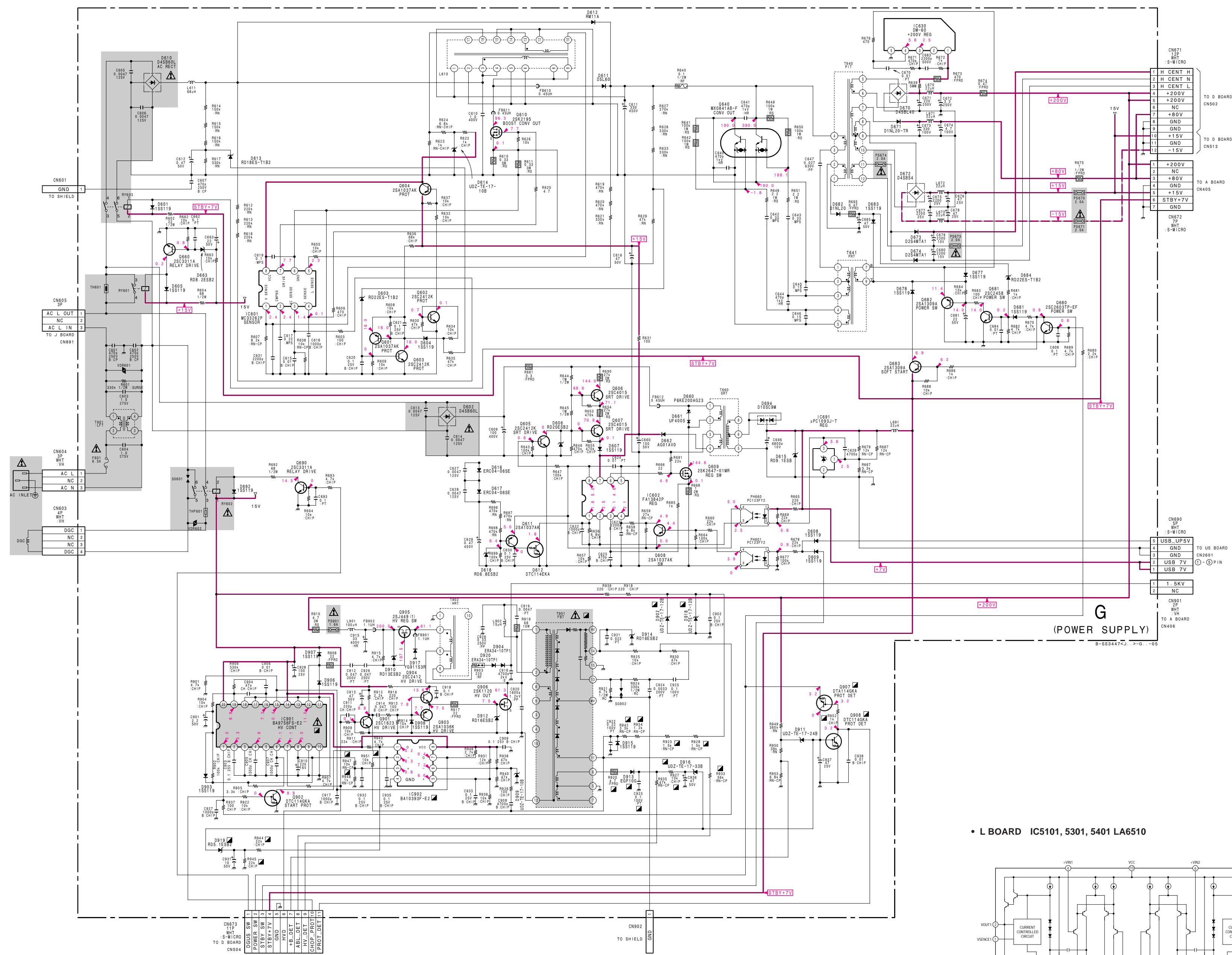

Schematic diagrams
 G, H1, H2
 J, L boards

— G BOARD —

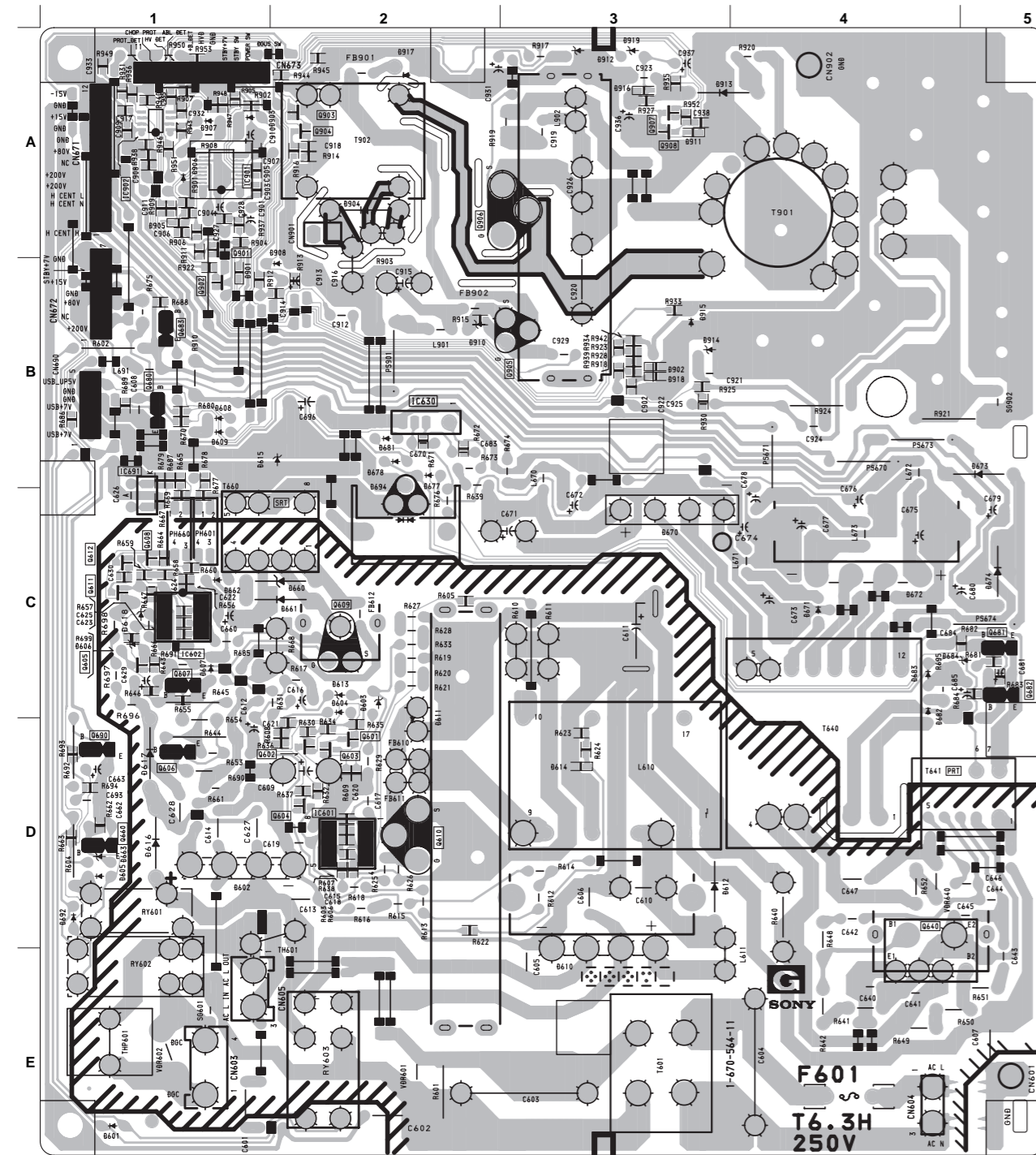

G BOARD
Terminal name of semiconductors
in silk screen printed circuit (*)

Ref.	*
Q601-Q605, Q608, Q611 Q612, Q901-Q904, Q907, Q908	①
D614, D902, D911, D916, D918	③

※: Refer to Terminal name of semiconductors
in silk screen printed circuit (see page 5-9)

G [POWER SUPPLY]

H₁ [USER CONTROL]

H₂ [USER CONTROL]

J [POWER SW]

L V. STAT, H. STAT, LCC,
GEO MAGNETIC SENSOR

— H1 BOARD —

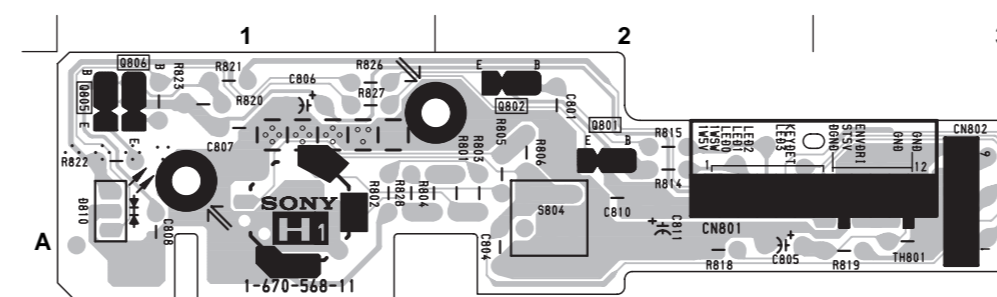

— H2 BOARD —

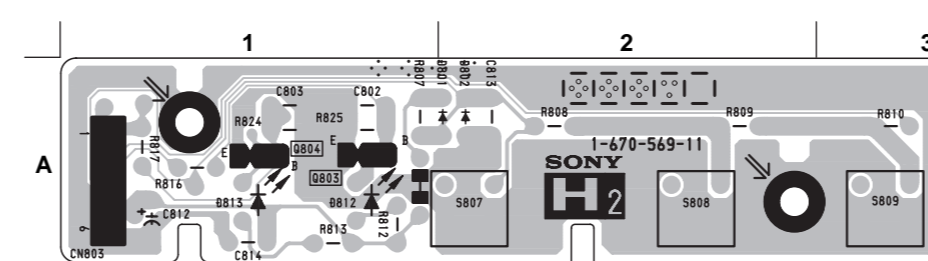

— J BOARD —

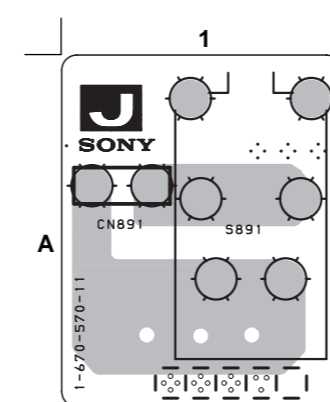

— L BOARD (Conductor Side) —

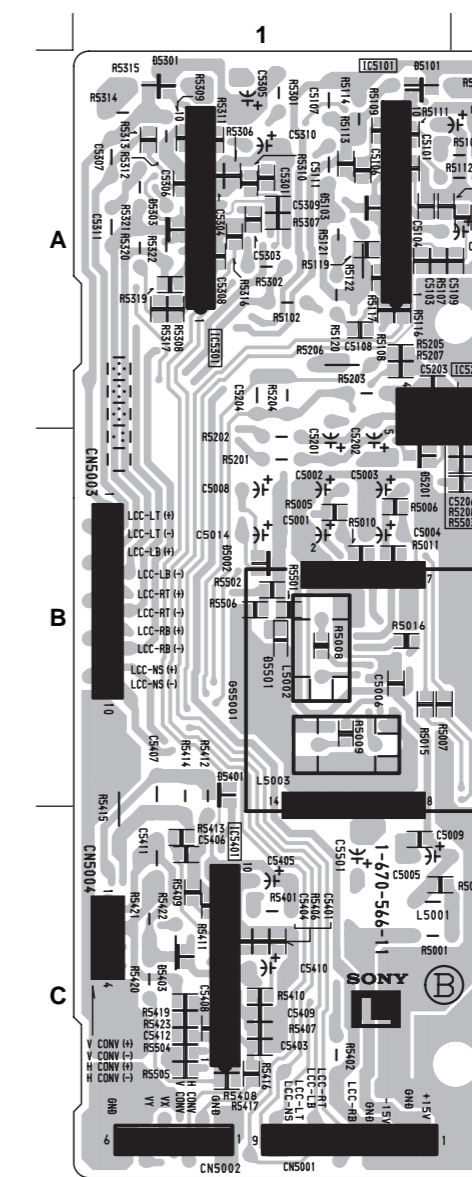

L BOARD
Terminal name of semiconductors
in silk screen printed circuit (*)

Ref.	*
D5501	③
D5101, D5103, D5201, D5301, D5303, D5401, D5403	⑥
D5002	⑧

※: Refer to Terminal name of
semiconductors in silk screen
printed circuit (see page 5-9)

— L BOARD (Component Side) —

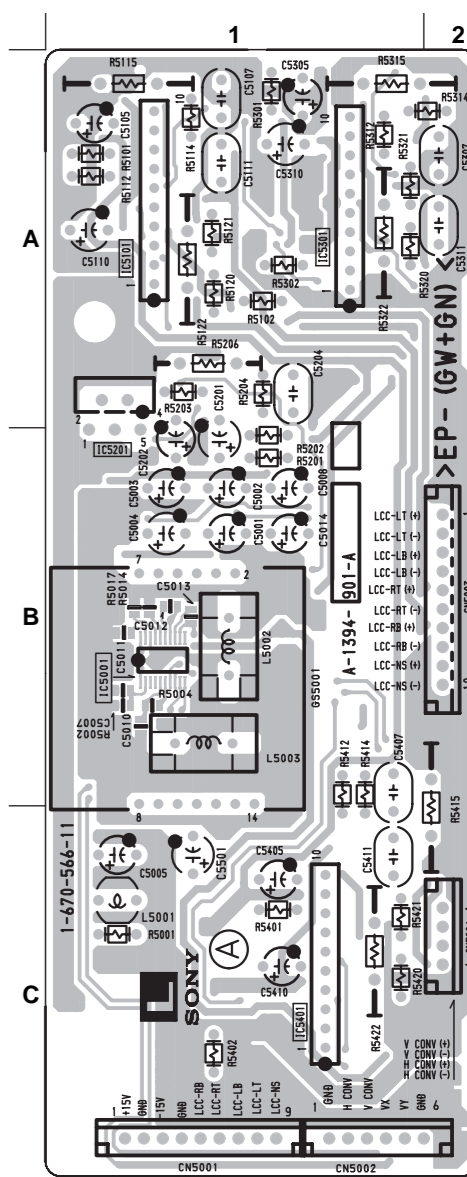

(3) Schematic Diagram of A Board

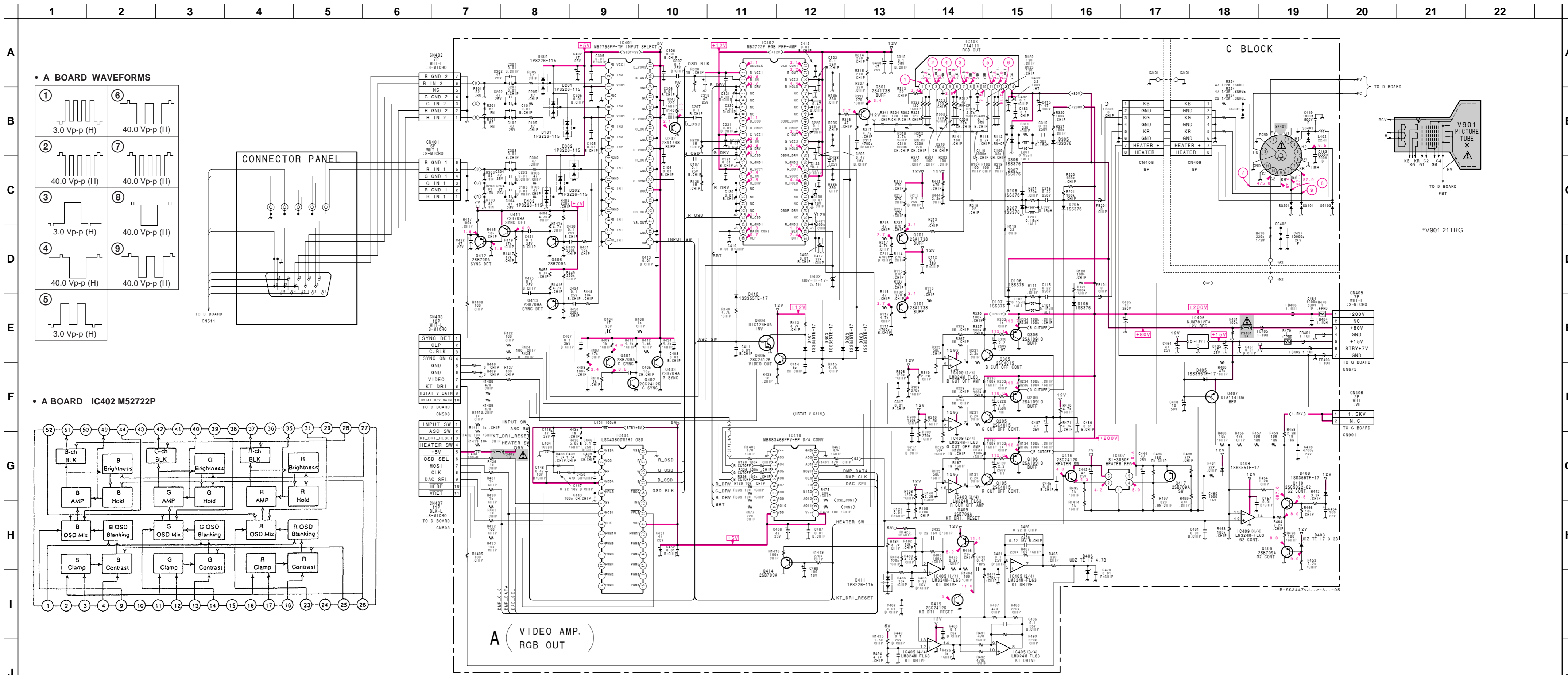

• A BOARD WAVEFORMS

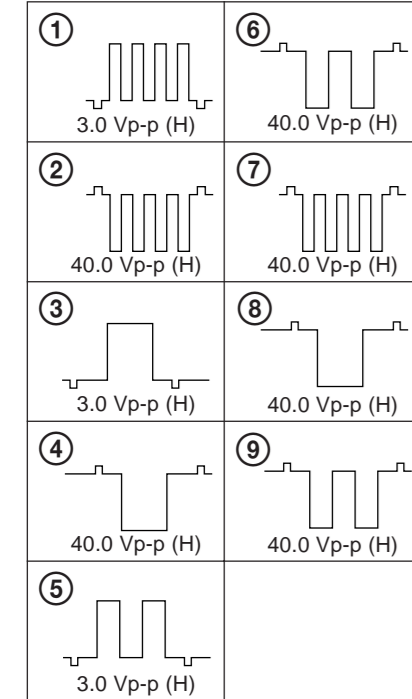

• A BOARD IC402 M52722P

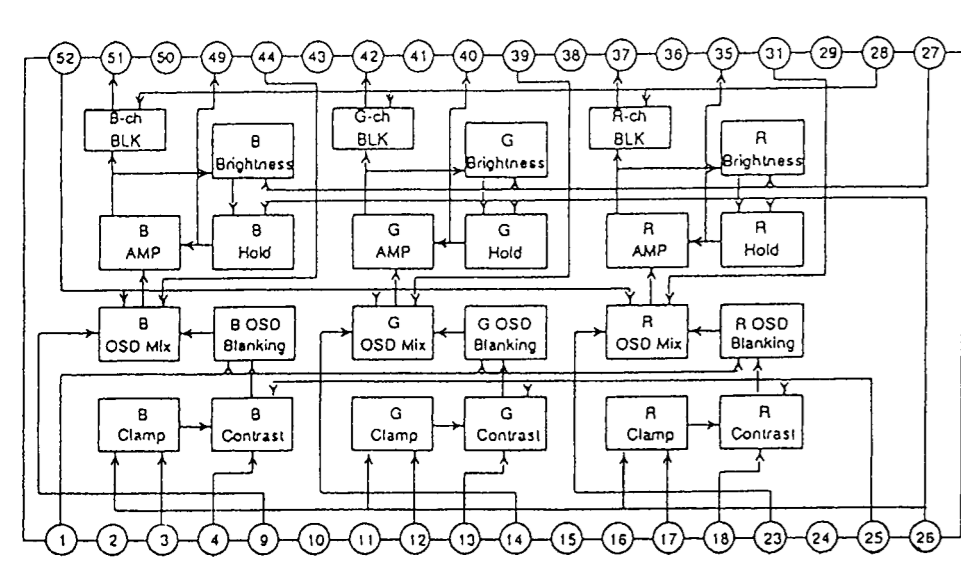

A (VIDEO AMP, RGB OUT)



VIDEO AMP
RGB OUT

— A BOARD (Conductor Side) —

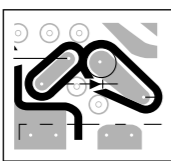
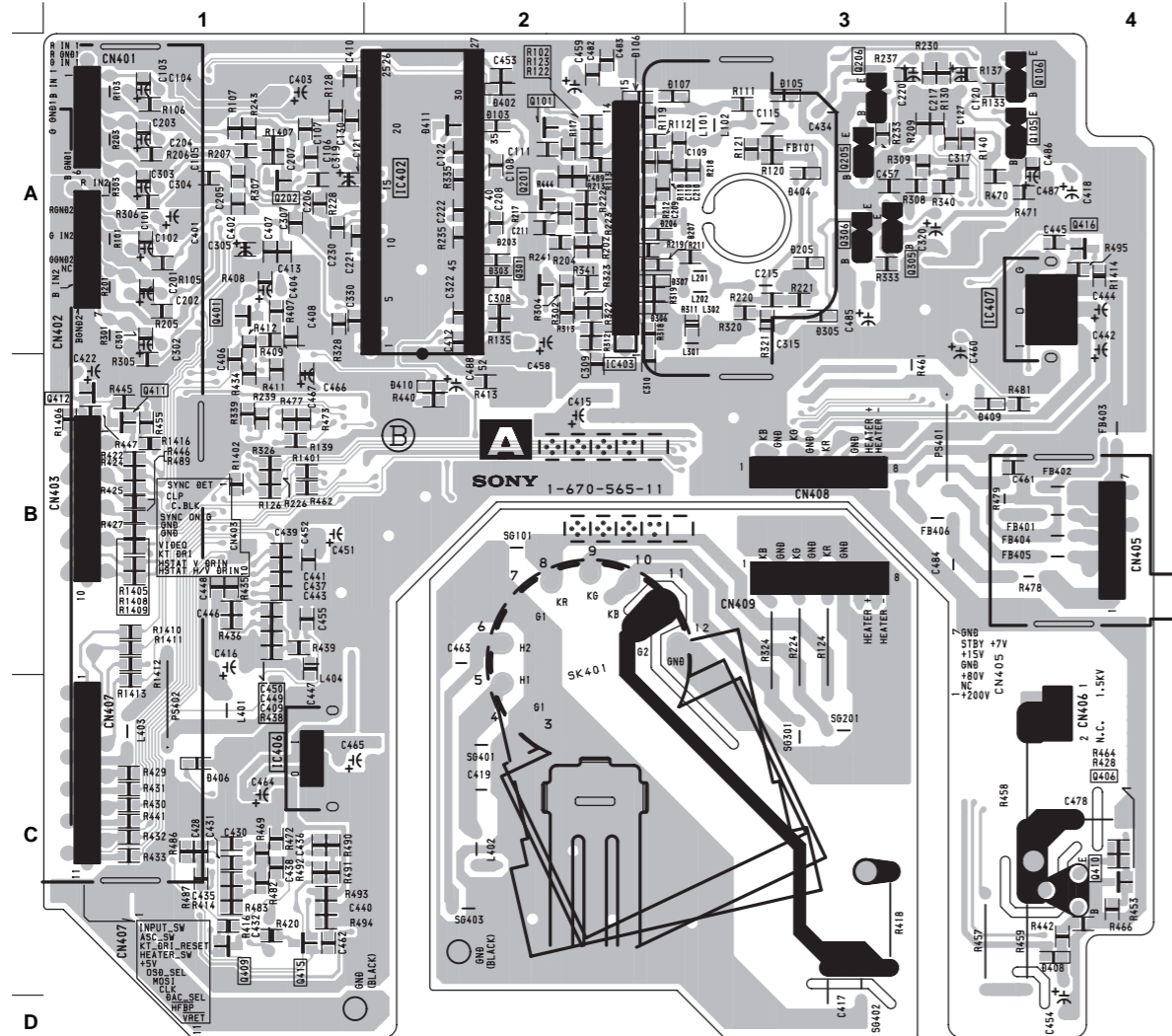

NOTE:
The circuit indicated as left contains high voltage of over 600 Vp-p. Care must be paid to prevent an electric shock in inspection or repairing.

• A BOARD
SEMICONDUCTOR
LOCATION

IC		(Conductor Side)	(Component Side)
IC401	A-1		
IC402	B-3		
IC403	B-3		
IC404	A-2		
IC406	A-1		
IC408	A-1		
IC409	C-1		
IC410	A-2		

TRANSISTOR		(Conductor Side)	(Component Side)	*
Q101	A-2		⊕	
Q105	A-4		⊕	
Q106	A-4		⊕	
Q201	A-2		⊕	
Q202	A-1		⊕	
Q205	A-3		⊕	
Q206	A-3		⊕	
Q301	A-2		⊕	
Q305	A-3		⊕	
Q306	A-3		⊕	
Q401	A-1		⊕	
Q402	A-3		⊕	
Q403	B-3		⊕	
Q404	B-3		⊕	
Q405	B-2		⊕	
Q406	C-4		⊕	
Q407	A-1		⊕	
Q408	B-4		⊕	
Q409	C-1		⊕	
Q410	C-4		⊕	
Q411	B-1		⊕	
Q412	B-1		⊕	
Q413	B-4		⊕	
Q415	C-1		⊕	
Q416	A-4		⊕	
Q417	B-1		⊕	

DIODE		(Conductor Side)	(Component Side)	*
D101	A-4		⑦	
D102	A-4		⑦	
D103	A-2		③	
D105	A-3		③	
D106	A-2		③	
D107	A-2		③	
D201	A-4		⑦	
D202	A-4		⑦	
D203	A-2		③	
D205	A-3		③	
D206	A-2		③	
D207	A-3		③	
D301	A-4		③	
D302	A-4		③	
D303	A-2		③	
D305	A-3		③	
D306	A-2		③	
D307	A-2		③	
D401	B-3		③	
D402	A-2		③	
D403	C-1		③	
D405	A-1		③	
D406	C-1		③	
D408	C-4		③	
D409	B-3		③	
D410	B-2		③	

※: Refer to Terminal name of semiconductors in silk screen printed circuit (see page 5-9)

— A BOARD (Component Side) —

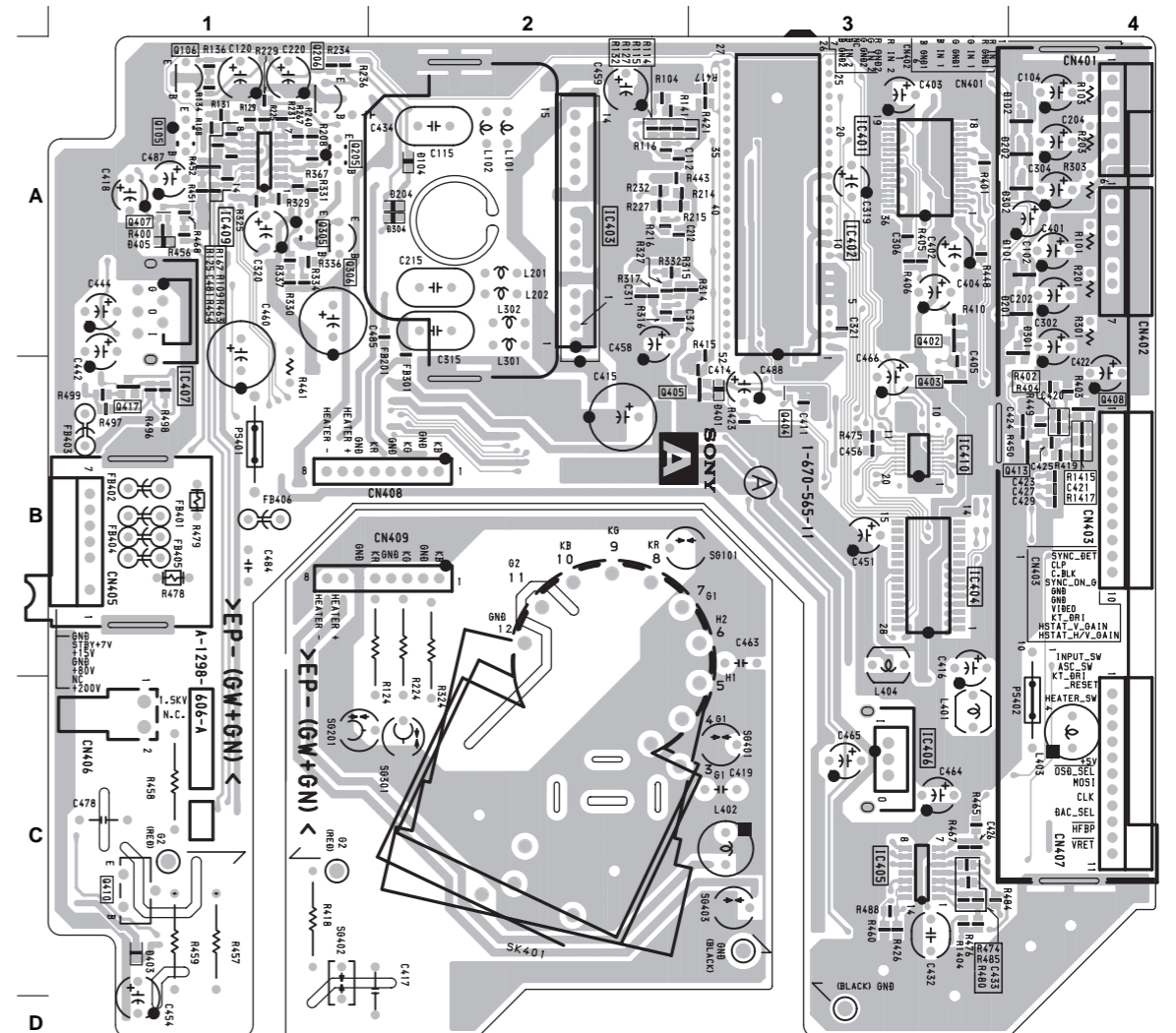

(4) Schematic Diagram of US Board (Old) (F500 (U/C) :S/N 2,700,001 to 2,701,030)
 F500 (AEP):S/N 2,800,001 to 2,801,280)

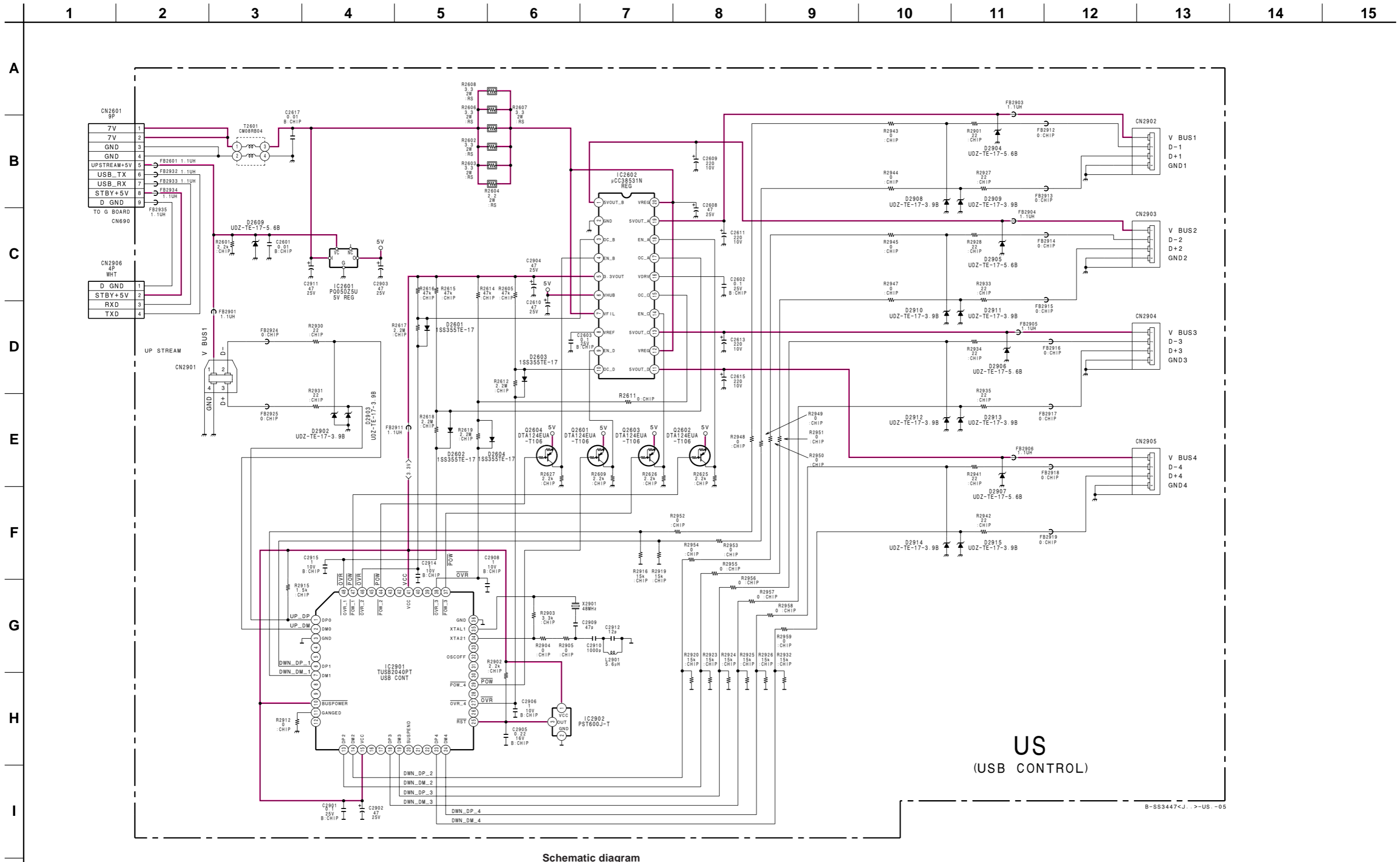

Schematic diagram
US board →

US (OLD) [USB CONTROL] (F500 (U/C) :S/N 2,700,001 to 2,701,030)
 (F500 (AEP):S/N 2,800,001 to 2,801,280)

US (NEW) [USB CONTROL] (F500 (U/C) :S/N 2,701,031 and later)
 (F500 (AEP):S/N 2,801,281 and later)
 F500T9 :All units

— US BOARD (Conductor Side) —

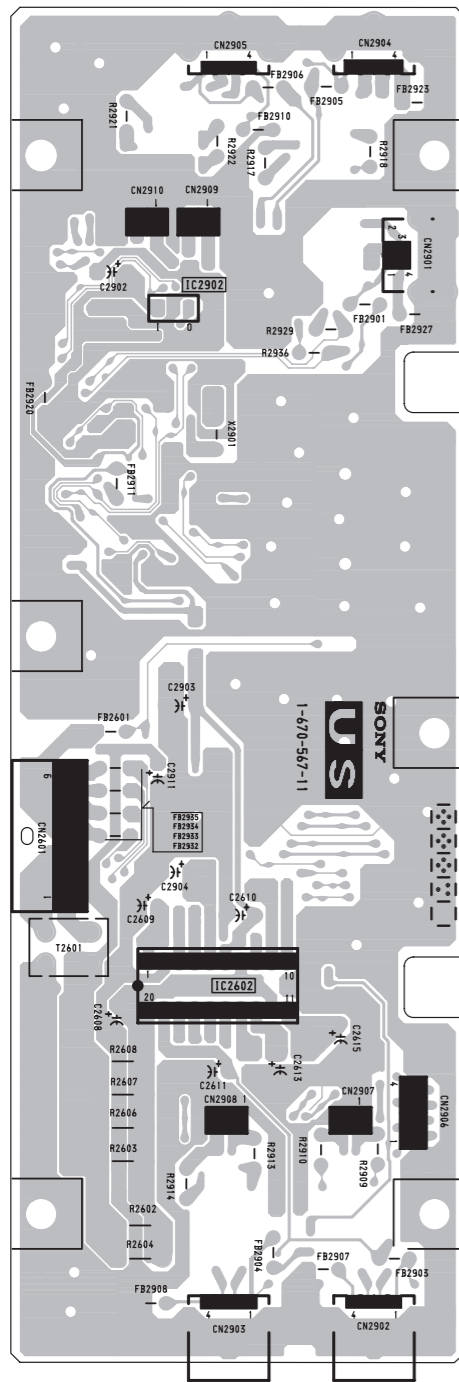

— US BOARD (Component Side) —

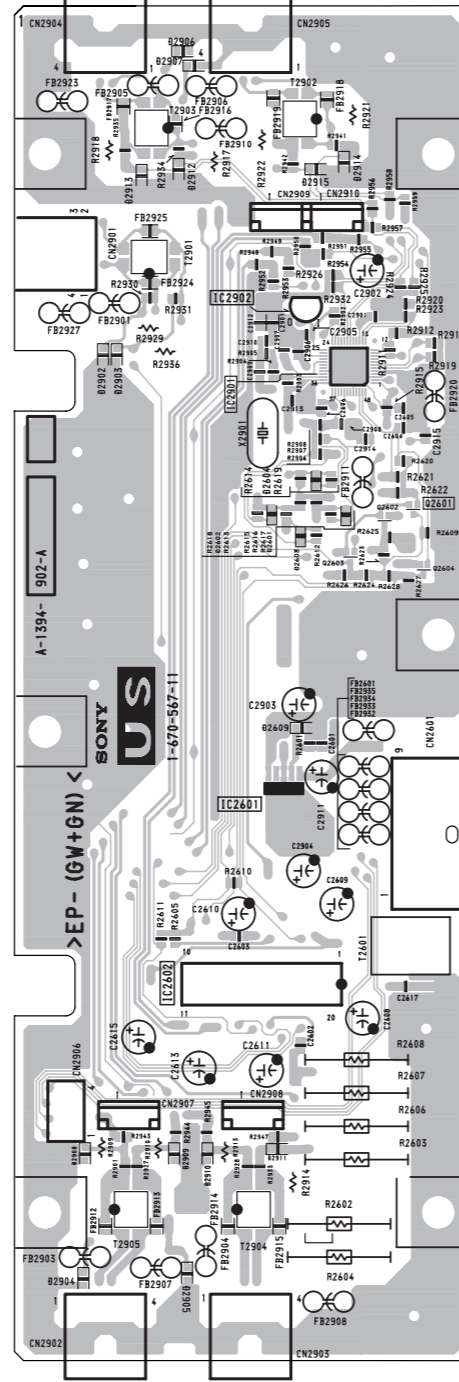

— US BOARD (Conductor Side) —

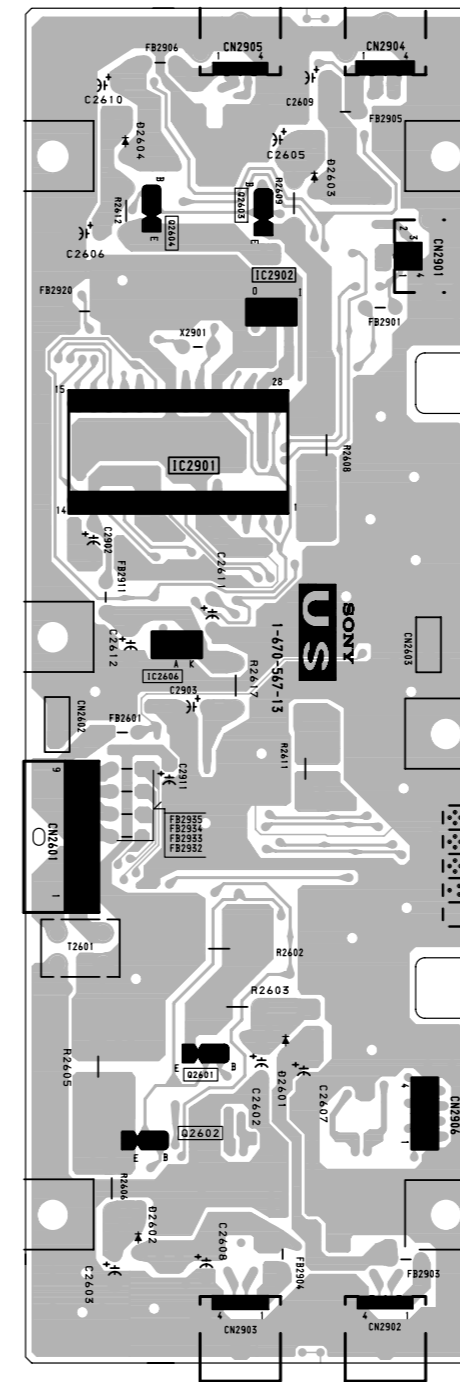

— US BOARD (Component Side) —

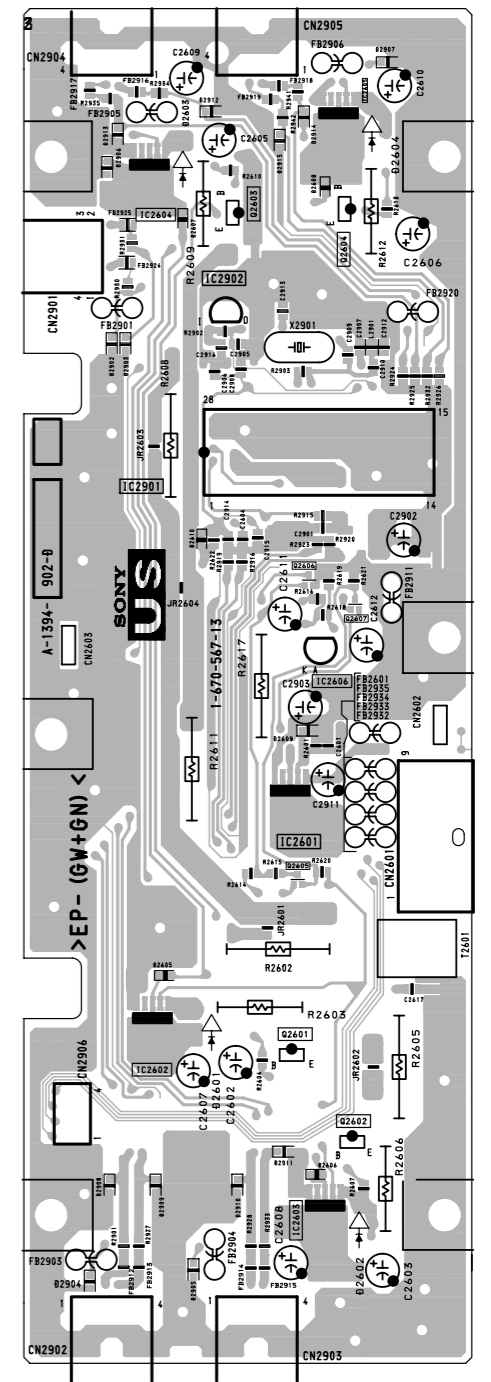

US BOARD (OLD)
 Terminal name of semiconductors
 in silk screen printed circuit (*):

Ref.	*
D2601-D2604, D2609, D2902-D2915	③

*: Refer to Terminal name of semiconductors
 in silk screen printed circuit (see page 5-9)

US BOARD (NEW)
 Terminal name of semiconductors
 in silk screen printed circuit (*):

Ref.	*
Q2605 - Q2607	②
D2605 - D2610, D2902 - D2915	③

*: Refer to Terminal name of semiconductors
 in silk screen printed circuit (see page 5-9)

(5) Schematic Diagram of US Board (New) (F500 (U/C) :S/N 2,701,031 and later)
 (F500 (AEP):S/N 2,801,281 and later)
 F500T9 :All units

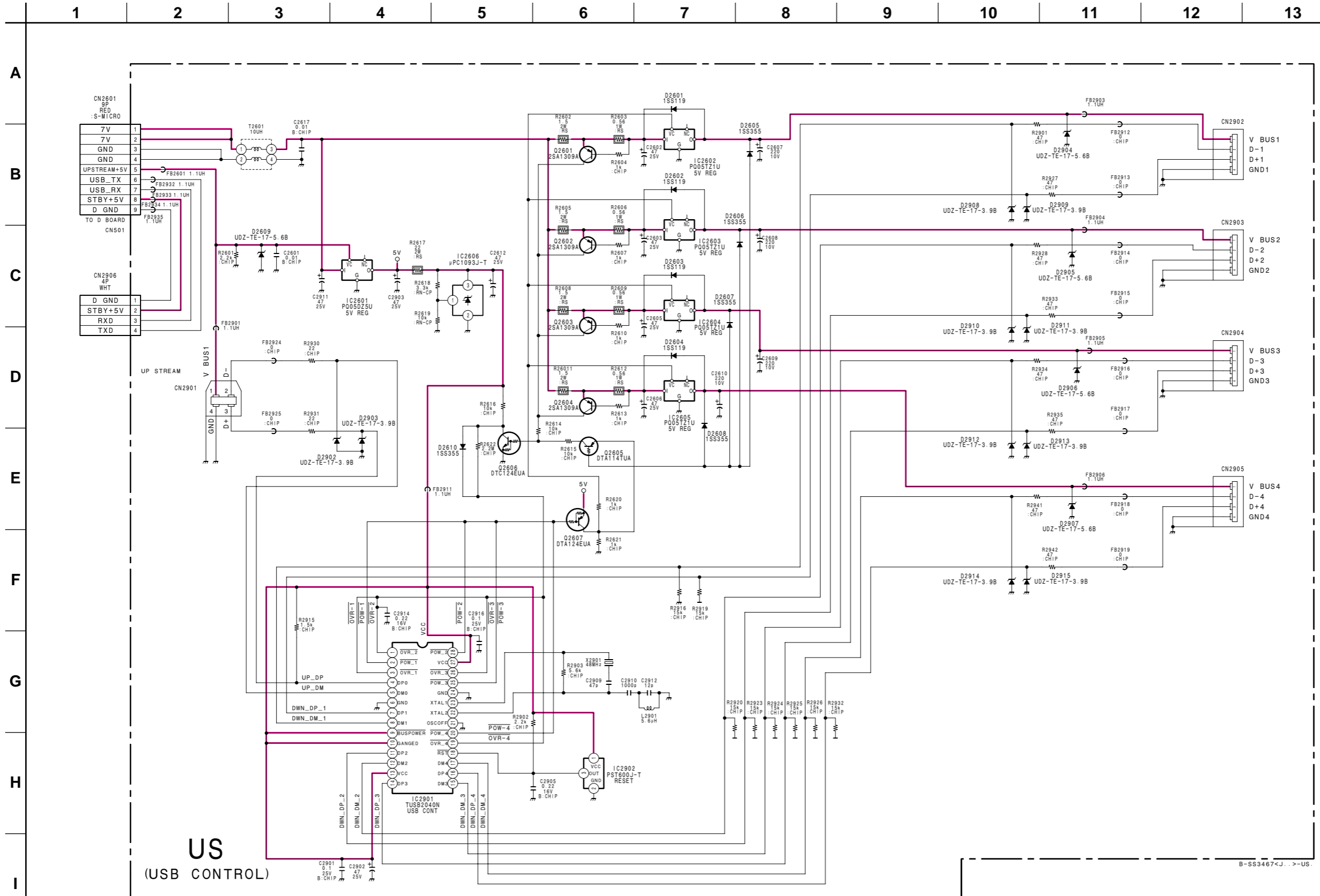

Schematic diagram
US board →

5-5. SEMICONDUCTORS

BA10393F-E2
NJM4558M
μPC4558G2
24LC21AT/SN

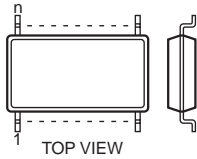

8 pin SOP

BA9756FS-E2
MB88346BPFV
MB88346BPFV-EF

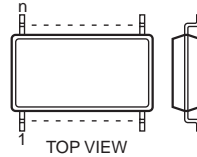

20 pin SOP

CXA2043Q

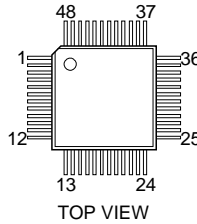

TOP VIEW

CXA2044M-T6
LSC4380DW2R2

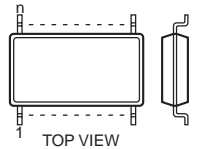

28 pin SOP

DM-60

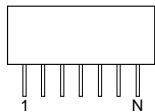

MARKING SIDE VIEW
• pin 1 N
• Mt (one side, both side)

FA4111

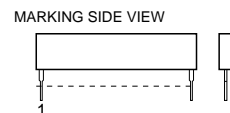

14 pin SIP

LA6500-FA

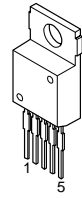

LA6510

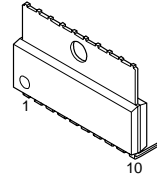

LA7841L

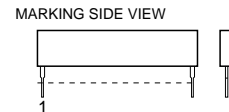

7 pin SIP

LM324M
TC74HCT04AF

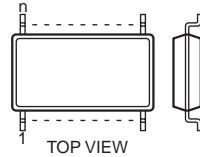

14 pin SOP

MB90F553APF-G-N01

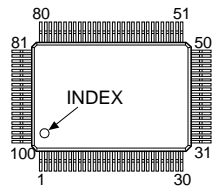

FA13842P
MC33262P
MM1170BFB
M24C16-MN6T

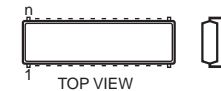

8 pin DIP

MC74HC4052F

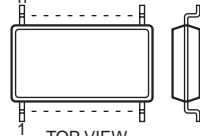

16 pin SOP

M52722P

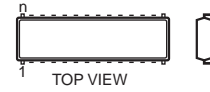

52 pin DIP

M52755FP-TP

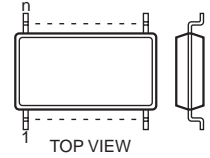

36 pin SOP

NJM082BM-T1

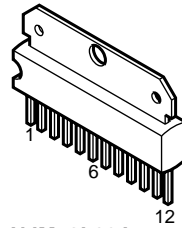

NJM78L09A
TA78L05S
TA78L09S



NJM78M09FA
TA7805S
TA7812S

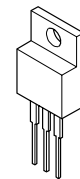

PST600J-T

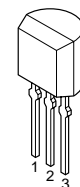

SI-3050F

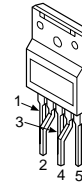

TUSB2040PT

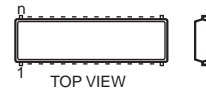

28 pin DIP

μPC1093J

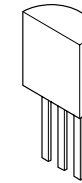

UCC38531N

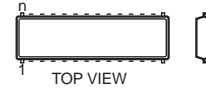

20 pin DIP

DTA114GKAT146
DTA114TUA-T106
DTA124EKA-T146
DTA124EUA-T106
DTC114EK
DTC114EKA-T146
DTC114GKA
DTC114GKAT146
2SA1036K-Q
2SA1036K-T-146-Q
2SA1037AK-T146-QR
2SA1037AK-T146-R
2SA1162-G
2SA1462-Y33
2SA1738-TX
2SB709A-QRS-TX
2SC1623-L5L6
2SC2412K-T-146-QR
MX0841AB-F

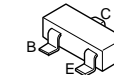

2SA1049-GR
2SC2458-YGR
2SC2603-EF
2SC2603TP-EF



2SA1091-O

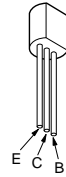

NJM7806FA
μPC24M06HF

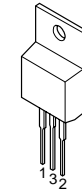

DTC124EUA-T106

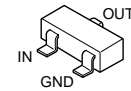

2SA1175-HFE
2SA1309A-QRSTA
2SC2459-GR-TPE4
2SC2784
2SC2785-HFE
2SC3311A-QRSTA

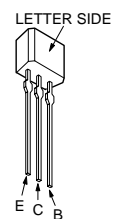

2SA1358-Y
2SC3421-Y

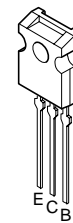

2SC2362K-G
2SC2362KG-AA



2SK2195F04

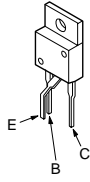

D1NL20-TR
D1NS4
RD13ES-B2
RD26ES-B2
RD22ES-B2
RD16ES-B3
RD18ES-B2
RD22ES-B2
RD5.1ES-B2
RD6.2ESB2
RD6.8ES-B2
RD8.2ES-B2
RD9.1ES-L
RD9.1ES-T1B
S2LA20F
1SS119-25TD
1SS119-25

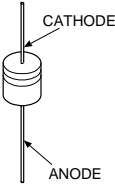

FMQ-G5GS
D5L60

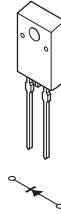

SB560

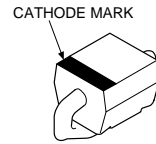

2SC3209LK

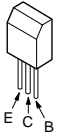

2SK2647-01MR-F91

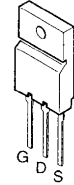

MA151WK-TX
1SS184

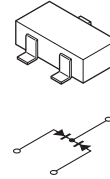

YG911S3R

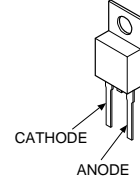

2SC3746
2SC4686A (LBSONY)
2SJ449
2SJ449 (1)
2SJ449 (2)

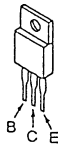

AG01A-V0
ERA91-02
EGP10D
EGP10GPKG23

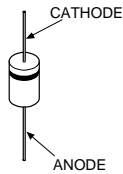

D2S4MF
D2S4MTA1

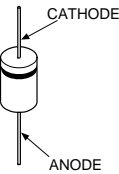

ON3171-R
PC123F2
PC123FY2

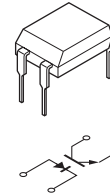

1PS226-115

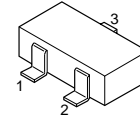

2SC4015TV2



DTZ-TT11-3.3B
DTZ10B
DTZ13B
DTZ24B
DTZ33B
DTZ4.7C
DTZ5.1B
DTZ9.1
MA111
MA111-TX
MA8039
RD12SB2
RD5.6S-B
RD6.2M-B1
UDZ-TE-17-10B
UDZ-TE-17-12B
UDZ-TE-17-13B
UDZ-TE-17-24B
UDZ-TE-17-33B
UDZ-TE-17-3.3B
UDZ-TE-17-3.9B
UDZ-TE-17-4.7B
UDZ-TE-17-5.1B
UDZ-TE-17-5.6B
UDZ-TE-17-6.2B
UDZ-TE-17-9.1B
1SS355
1SS355TE-17

D4SBS4
D4SBS4-F
D4SBL40
D4SB60L

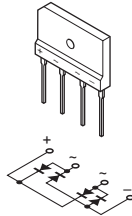

P6KE200AG23
UF4005PKG23

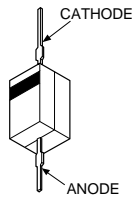

1SS376TE-17

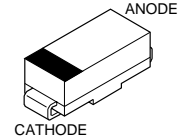

2SC5047S-SONY-CA

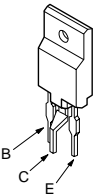

D10SC9M

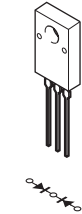

RD9.1ES-L2

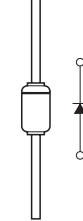

SLR-325YCT31

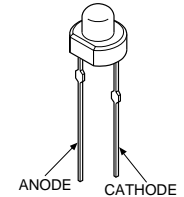

2SK1120LBSONY2

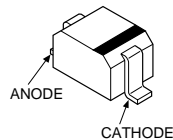
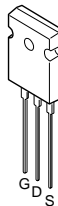

EGP20G
ERC04-06SE
RGP02-17EL-6433
RGP02-17PKG23
RGP02-20EG23
RGP15GPKG23

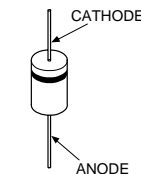

RM11A
RM11C

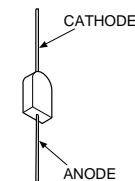

SECTION 6 EXPLODED VIEWS

- Items with no part number and no description are not stocked because they are seldom required for routine service.
- The construction parts of an assembled part are indicated with a collation number in the remark column.

- Items marked " * " are not stocked since they are seldom required for routine service. Some delay should be anticipated when ordering these items.

The components identified by shading and mark \triangle are critical for safety. Replace only with part number specified.

Les composants identifiés par un tramé et une marque \triangle sont critiques pour la sécurité. Ne les remplacer que par une pièce portant le numéro spécifié.

6-1. CHASSIS

- ▲ 7-685-647-79 +BVTP 3X10
- 7-685-663-71 +BVTP 4X16
- △ 7-685-881-09 +BVTT 4X8

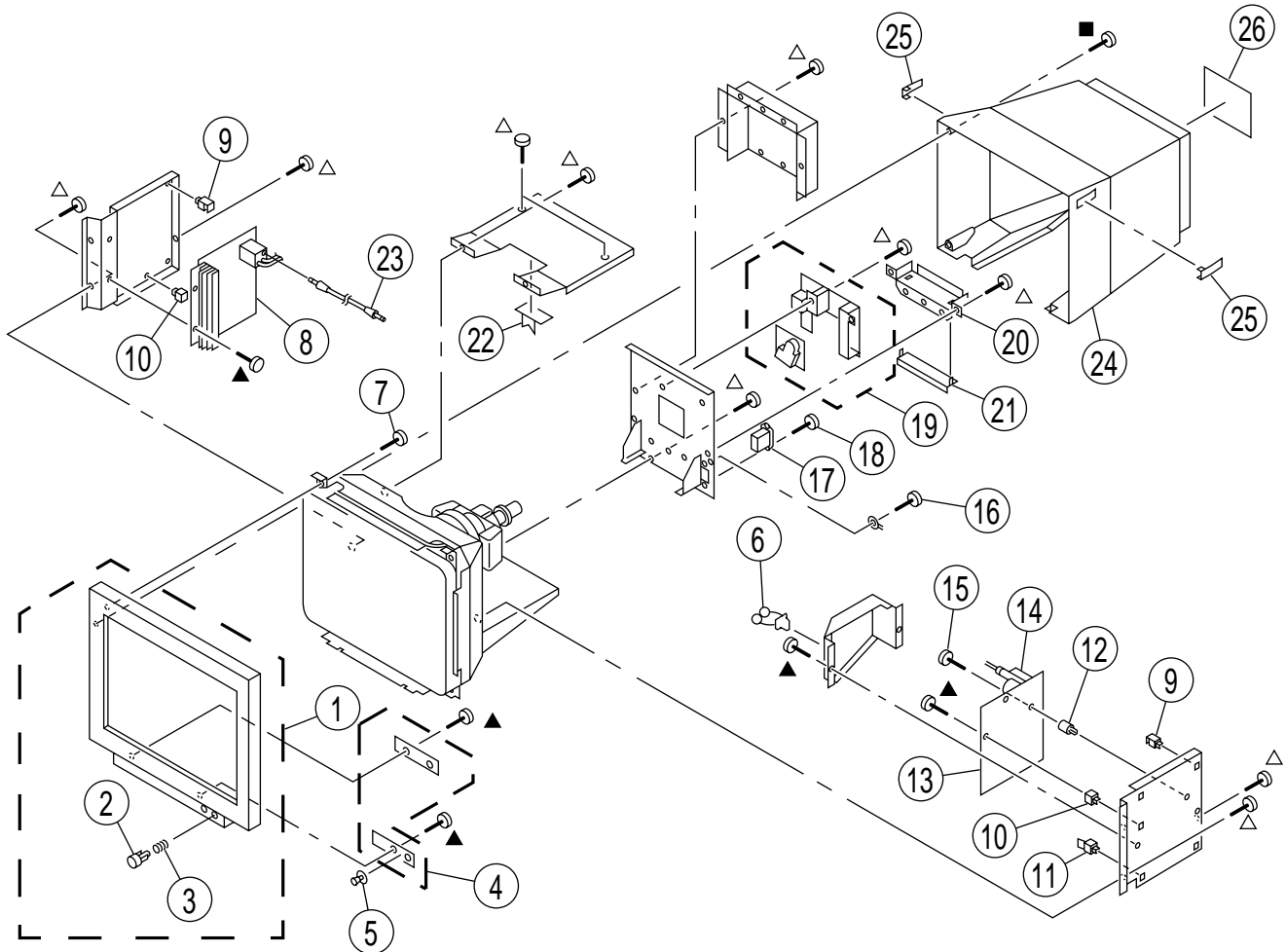

REF.NO.	PART NO.	DESCRIPTION	REMARK	REF.NO.	PART NO.	DESCRIPTION	REMARK
1	X-4035-841-1	BEZEL ASSY	2, 3	15	4-062-115-01	SCREW +P 3.5X20 TYPE2	
2	4-065-308-01	BUTTON, POWER		16	4-389-025-01	SCREW (M4) (EXT TOOTH WASHER)	
3	3-653-339-01	SPRING, COMPRESSION		17	△ 1-251-382-12	INLET, AC 3P (WITH NOISE FILTER)	
4	* 8-933-324-00	H1, H2 BOARD, COMPLETE		18	4-052-345-01	SCREW, (3X8) (+K), TAPPING	
5	4-065-309-01	KNOB (MENU)		19	* 8-933-318-00	A BOARD, COMPLETE	
6	2-132-434-01	CLIP, WIRE		20	1-694-456-11	TERMINAL BOARD ASSY, I/O	
7	4-365-808-01	SCREW (5), TAPPING		21	4-065-315-01	ATTACHMENT	
8	* 8-933-319-00	D BOARD, COMPLETE		22	* 4-063-711-01	SUPPORT, HV CABLE	
9	* 3-701-903-11	HOLDER, PRINTED CIRCUIT BOARD		23	1-900-215-90	CONNECTOR ASSY	
10	* 4-382-848-01	HOLDER, PRINTED CIRCUIT BOARD		24	4-065-325-01	CABINET	
11	* 3-703-141-00	HOLDER, PRINTED CIRCUIT BOARD		25	4-065-304-01	COVER, SCREW	
12	* 4-060-359-01	HOLDER, PRINTED CIRCUIT BOARD		26	* 4-066-155-01	LABEL, INFORMATION [F500 (U/C)]	
13	* 8-933-320-00	G BOARD, COMPLETE		26	* 4-066-156-01	LABEL, INFORMATION [F500 (AEP)]	
14	△ X-4034-094-1	TRANSFORMER ASSY, FLYBACK (NX-4202//J1D4)		26	* 4-066-156-11	LABEL, INFORMATION [F500T9]	

6-2. PICTURE TUBE

- ▲ 7-685-647-79 +BVTP 3X10
- 7-685-663-71 +BVTP 4X16
- △ 7-685-881-09 +BVTT 4X8

The components identified by shading and mark △ are critical for safety. Replace only with part number specified.

Les composants identifiés par un trame et une marque △ sont critiques pour la sécurité. Ne les remplacer que par une pièce portant le numéro spécifié.

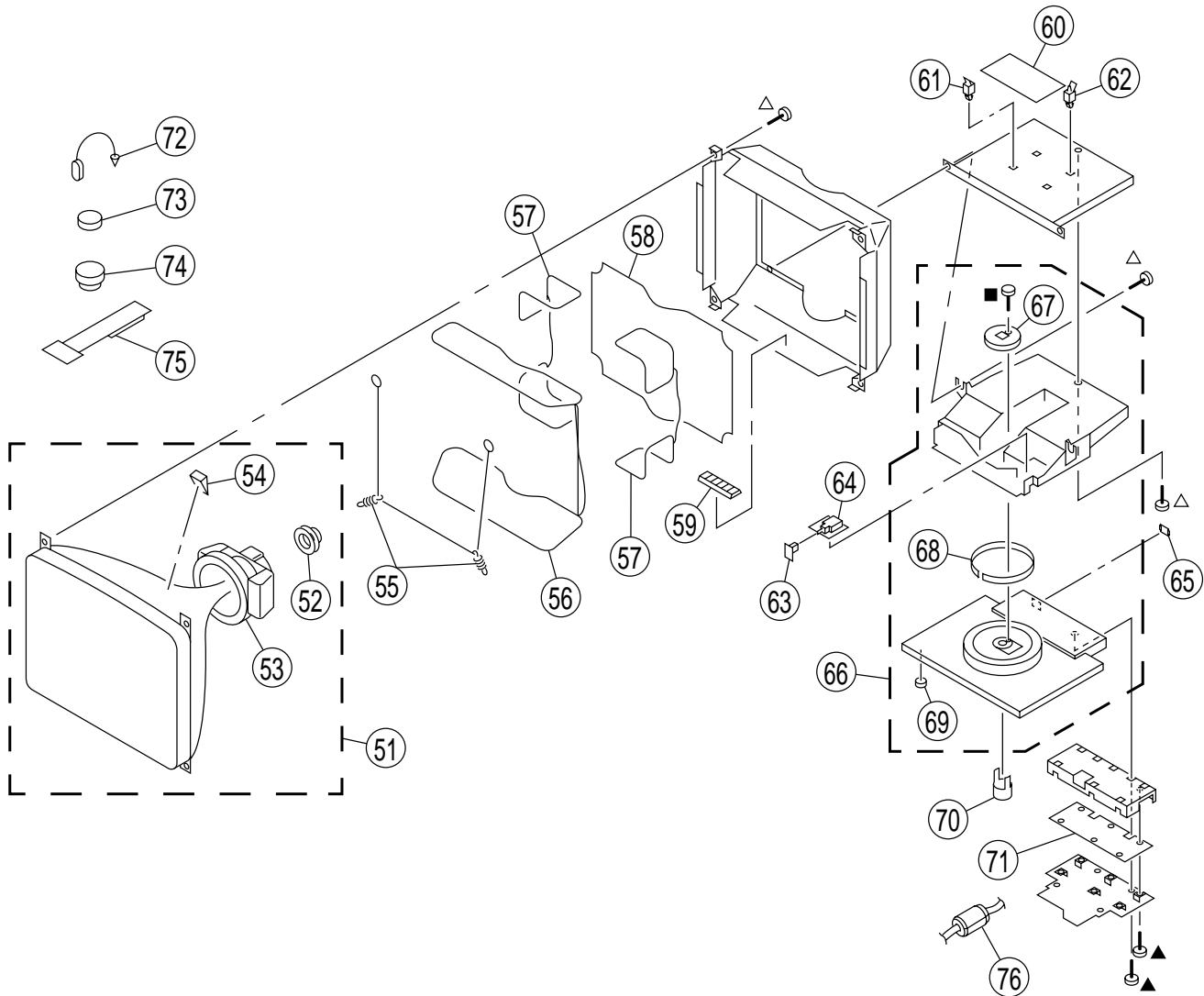

REF.NO.	PART NO.	DESCRIPTION	REMARK	REF.NO.	PART NO.	DESCRIPTION	REMARK
51	△ 8-738-804-81	ITC ASSY (21TRG-R1)	52-54	66	X-4035-843-1	STAND ASSY [F500]	67-69
52	△ 1-452-912-31	NECK ASSY, PICTURE TUBE (NA2914)		66	X-4036-738-1	STAND ASSY [F500T9]	67-69
53	△ 8-451-502-12	DEFLECTION YOKE (Y21TRL-M)		67	4-061-396-01	STOPPER (A)	
54	4-050-492-01	SPACER, DEFLECTION YOKE		68	4-060-339-01	RING, TILT SWIVEL	
55	* 4-047-316-01	SPRING, EXTENSION		69	4-047-474-01	FOOT, RUBBER	
56	△ 1-416-792-11	COIL, DEMAGNETIC		70	4-062-381-01	STOPPER (B)	
57	△ 1-416-794-11	COIL, LANDING CORRECTION		71	* 8-933-321-00	US BOARD, COMPLETE	
58	△ 1-416-793-11	COIL, LANDING CORRECTION				Note: Old model and new model of US complete board have interchangeability, and only new model of US complete board is supplied.	
59	4-062-670-01	SPACER, PICTURE TUBE		72	4-308-870-00	CLIP, LEAD WIRE	
60	* 8-933-325-00	L BOARD, COMPLETE		73	1-452-032-00	MAGNET, DISK: 10mm φ	
61	* 4-321-929-00	HOLDER, PRINTED CIRCUIT BOARD		74	1-452-094-00	MAGNET, ROTATABLE DISK; 15mm φ	
62	* 3-703-141-00	HOLDER, PRINTED CIRCUIT BOARD		75	4-051-736-21	PIECE A (90), CONV. CORRECT	
63	4-065-310-01	CAP, POWER		76	1-543-798-11	FILTER, CLAMP (FERRITE CORE)	
64	* 8-933-322-00	J BOARD, COMPLETE					
65	4-065-302-01	COVER, ECS					

6-3. PACKING MATERIALS

The components identified by shading and mark Δ are critical for safety. Replace only with part number specified.

Les composants identifiés par un trame et une marque Δ sont critiques pour la sécurité. Ne les remplacer que par une pièce portant le numéro spécifié.

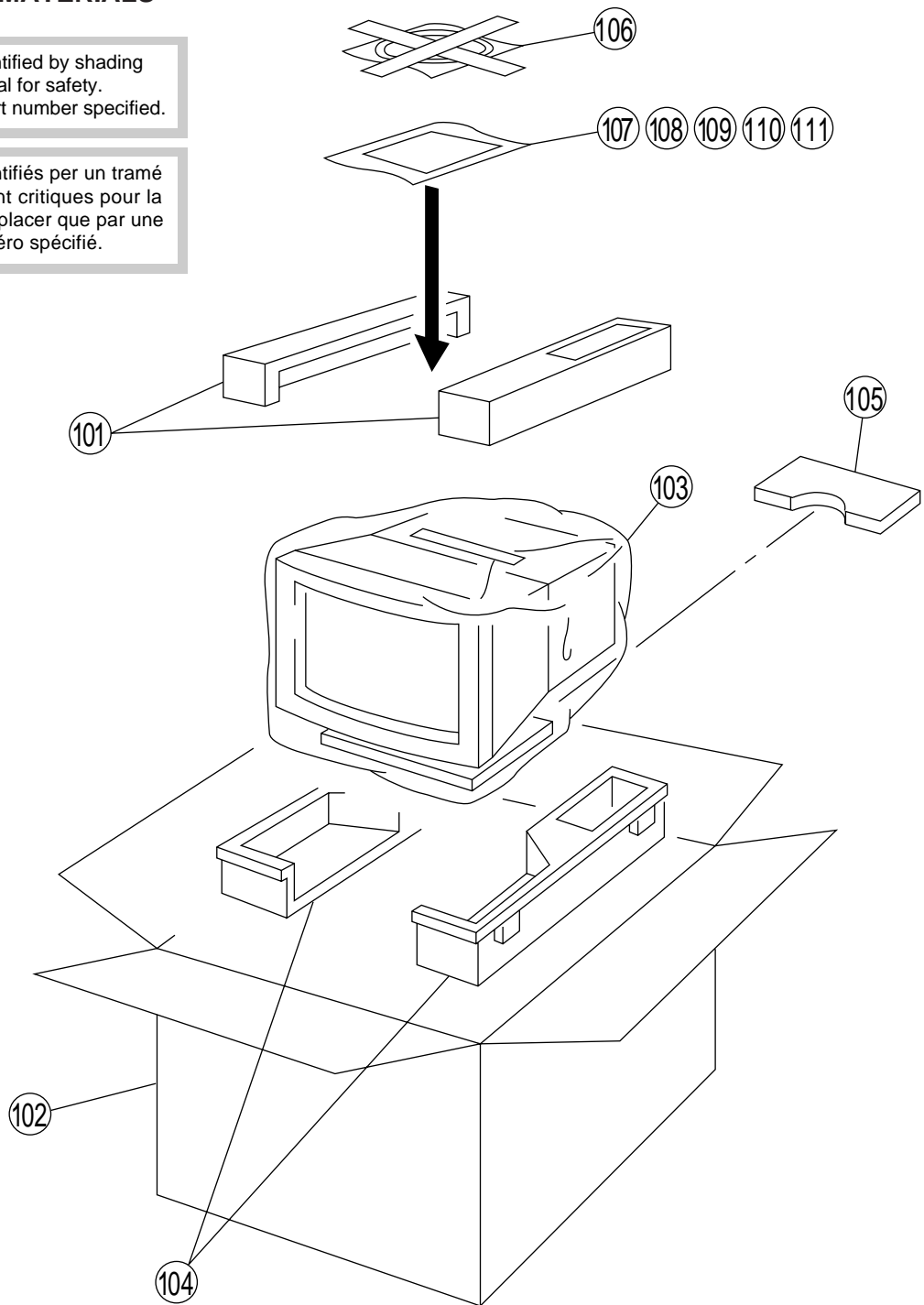

REF.NO.	PART NO.	DESCRIPTION	REMARK	REF.NO.	PART NO.	DESCRIPTION	REMARK
101	*4-065-176-01	CUSHION (UPPER) (ASSY)		108	1-790-081-21	CABLE, USB	
102	*4-066-792-01	INDIVIDUAL CARTON [F500 (U/C)]		109	1-785-429-11	ADAPTOR, CONVERSION (for Macintosh)	
102	*4-066-791-01	INDIVIDUAL CARTON [F500 (AEP)]		110	Δ 1-782-783-11	CORD SET, POWER [F500 (U/C)]	
102	*4-070-119-01	INDIVIDUAL CARTON [F500T9]		110	Δ 1-782-784-11	CORD SET, POWER	
103	*4-041-927-31	BAG, POLYETHYLENE				[F500 (AEP)/F500T9]	
104	*4-065-177-01	CUSHION (LOWER) (ASSY)		111	3-864-156-11	MANUAL, INSTRUCTION [F500 (AEP)]	
105	*4-066-347-01	PAD FOR TILT FIXING		111	3-864-156-22	MANUAL, INSTRUCTION [F500 (U/C)]	
106	1-777-743-11	CABLE ASSY (15P DSUB X2 CONNECTOR)		111	3-864-156-31	MANUAL, INSTRUCTION [F500T9] (ENGLISH, FRENCH, GERMAN, SPANISH, ITALIAN)	
107	1-759-641-14	DISK, INFORMATION (for Windows)		111	3-864-156-41	MANUAL, INSTRUCTION [F500T9] (RUSSIAN, POLISH, SLOVENE, HUNGARIAN, CZECK)	

MEMO

A series of horizontal dotted lines for writing.

SECTION 7

ELECTRICAL PARTS LIST



NOTE:

The components identified by shading and mark Δ are critical for safety. Replace only with part number specified.

Les composants identifiés par un tramé et une marque Δ sont critiques pour la sécurité. Ne les remplacer que par une pièce portant le numéro spécifié.

When indicating parts by reference number, please include the board name.

• All variable and adjustable resistors have characteristic curve B, unless otherwise noted.

RESISTORS

• All resistors are in ohms
• F : nonflammable

• Items marked " * " are not stocked since they are seldom required for routine service. Some delay should be anticipated when ordering these items.

CAPACITORS

MF : μ F
COILS
UH : μ H

REF.NO.	PART NO.	DESCRIPTION	REMARK	REF.NO.	PART NO.	DESCRIPTION	REMARK
	* 8-933-318-00	A BOARD, COMPLETE *****		C221	1-163-021-91	CERAMIC CHIP 0.01 μ F	10% 50V
				C222	1-164-004-11	CERAMIC CHIP 0.1 μ F	10% 25V
	4-382-854-11	SCREW (M3X10), P, SW (+) (IC403, IC407)		C230	1-163-021-91	CERAMIC CHIP 0.01 μ F	10% 50V
				C301	1-163-021-91	CERAMIC CHIP 0.01 μ F	10% 50V
				C302	1-104-664-11	ELECT 47 μ F	20% 25V
				C303	1-163-021-91	CERAMIC CHIP 0.01 μ F	10% 50V
				C304	1-104-664-11	ELECT 47 μ F	20% 25V
		<CAPACITOR>		C305	1-163-021-91	CERAMIC CHIP 0.01 μ F	10% 50V
C101	1-163-021-91	CERAMIC CHIP 0.01 μ F	10% 50V	C306	1-163-021-91	CERAMIC CHIP 0.01 μ F	10% 50V
C102	1-104-664-11	ELECT 47 μ F	20% 25V	C307	1-164-004-11	CERAMIC CHIP 0.1 μ F	10% 25V
C103	1-163-021-91	CERAMIC CHIP 0.01 μ F	10% 50V	C308	1-107-823-11	CERAMIC CHIP 0.47 μ F	10% 16V
C104	1-104-664-11	ELECT 47 μ F	20% 25V	C309	1-163-237-11	CERAMIC CHIP 27pF	5% 50V
C105	1-163-021-91	CERAMIC CHIP 0.01 μ F	10% 50V	C310	1-163-275-11	CERAMIC CHIP 0.001 μ F	5% 50V
C106	1-163-021-91	CERAMIC CHIP 0.01 μ F	10% 50V	C311	1-163-017-00	CERAMIC CHIP 0.0047 μ F	10% 50V
C107	1-164-004-11	CERAMIC CHIP 0.1 μ F	10% 25V	C312	1-164-004-11	CERAMIC CHIP 0.1 μ F	10% 25V
C108	1-107-823-11	CERAMIC CHIP 0.47 μ F	10% 16V	C315	1-104-514-11	FILM 0.22 μ F	10% 250V
C109	1-163-239-11	CERAMIC CHIP 33pF	5% 50V	C317	1-163-021-91	CERAMIC CHIP 0.01 μ F	10% 50V
C110	1-163-275-11	CERAMIC CHIP 0.001 μ F	5% 50V	C319	1-107-888-11	ELECT 47 μ F	20% 25V
C111	1-163-017-00	CERAMIC CHIP 0.0047 μ F	10% 50V	C320	1-107-958-11	ELECT 2.2 μ F	20% 250V
C112	1-164-004-11	CERAMIC CHIP 0.1 μ F	10% 25V	C321	1-163-021-91	CERAMIC CHIP 0.01 μ F	10% 50V
C115	1-104-514-11	FILM 0.22 μ F	10% 250V	C322	1-164-004-11	CERAMIC CHIP 0.1 μ F	10% 25V
C120	1-107-958-11	ELECT 2.2 μ F	20% 250V	C330	1-163-021-91	CERAMIC CHIP 0.01 μ F	10% 50V
C121	1-163-021-91	CERAMIC CHIP 0.01 μ F	10% 50V	C402	1-104-664-11	ELECT 47 μ F	20% 25V
C122	1-164-004-11	CERAMIC CHIP 0.1 μ F	10% 25V	C404	1-104-664-11	ELECT 47 μ F	20% 25V
C127	1-163-021-91	CERAMIC CHIP 0.01 μ F	10% 50V	C405	1-163-227-11	CERAMIC CHIP 10pF	0.5pF 50V
C130	1-163-021-91	CERAMIC CHIP 0.01 μ F	10% 50V	C407	1-164-004-11	CERAMIC CHIP 0.1 μ F	10% 25V
C201	1-163-021-91	CERAMIC CHIP 0.01 μ F	10% 50V	C408	1-163-021-91	CERAMIC CHIP 0.01 μ F	10% 50V
C202	1-104-664-11	ELECT 47 μ F	20% 25V	C409	1-163-235-11	CERAMIC CHIP 22pF	5% 50V
C203	1-163-021-91	CERAMIC CHIP 0.01 μ F	10% 50V	C410	1-163-021-91	CERAMIC CHIP 0.01 μ F	10% 50V
C204	1-104-664-11	ELECT 47 μ F	20% 25V	C411	1-163-021-91	CERAMIC CHIP 0.01 μ F	10% 50V
C205	1-163-021-91	CERAMIC CHIP 0.01 μ F	10% 50V	C412	1-163-021-91	CERAMIC CHIP 0.01 μ F	10% 50V
C206	1-163-021-91	CERAMIC CHIP 0.01 μ F	10% 50V	C413	1-163-021-91	CERAMIC CHIP 0.01 μ F	10% 50V
C207	1-164-004-11	CERAMIC CHIP 0.1 μ F	10% 25V	C414	1-163-222-11	CERAMIC CHIP 5pF	0.25pF 50V
C208	1-107-823-11	CERAMIC CHIP 0.47 μ F	10% 16V	C415	1-128-562-11	ELECT 47 μ F	20% 100V
C209	1-163-237-11	CERAMIC CHIP 27pF	5% 50V	C416	1-104-664-11	ELECT 47 μ F	20% 25V
C210	1-163-275-11	CERAMIC CHIP 0.001 μ F	5% 50V	C417	1-115-349-51	CERAMIC 0.01 μ F	2KV
C211	1-163-017-00	CERAMIC CHIP 0.0047 μ F	10% 50V	C418	1-126-964-11	ELECT 10 μ F	20% 50V
C212	1-164-004-11	CERAMIC CHIP 0.1 μ F	10% 25V	C419	1-162-318-11	CERAMIC 0.001 μ F	10% 500V
C215	1-104-514-11	FILM 0.22 μ F	10% 250V	C420	1-164-004-11	CERAMIC CHIP 0.1 μ F	10% 25V
C217	1-163-021-91	CERAMIC CHIP 0.01 μ F	10% 50V	C421	1-164-004-11	CERAMIC CHIP 0.1 μ F	10% 25V
C220	1-107-958-11	ELECT 2.2 μ F	20% 250V	C422	1-104-664-11	ELECT 47 μ F	20% 25V

GDM-F500/F500T9



REF.NO.	PART NO.	DESCRIPTION	REMARK	REF.NO.	PART NO.	DESCRIPTION	REMARK
C424	1-164-004-11	CERAMIC CHIP 0.1μF	10% 25V				
C425	1-164-004-11	CERAMIC CHIP 0.1μF	10% 25V				
C426	1-164-489-11	CERAMIC CHIP 0.22μF	10% 16V				
C428	1-164-489-11	CERAMIC CHIP 0.22μF	10% 16V				
C431	1-164-004-11	CERAMIC CHIP 0.1μF	10% 25V				
C432	1-137-194-81	FILM 0.47μF	5% 50V				
C433	1-164-489-11	CERAMIC CHIP 0.22μF	10% 16V				
C435	1-164-489-11	CERAMIC CHIP 0.22μF	10% 16V				
C436	1-164-004-11	CERAMIC CHIP 0.1μF	10% 25V				
C438	1-164-004-11	CERAMIC CHIP 0.1μF	10% 25V				
C440	1-164-004-11	CERAMIC CHIP 0.1μF	10% 25V				
C442	1-104-664-11	ELECT 47μF	20% 25V				
C443	1-163-251-11	CERAMIC CHIP 100pF	5% 50V				
C444	1-104-664-11	ELECT 47μF	20% 25V				
C445	1-163-021-91	CERAMIC CHIP 0.01μF	10% 50V				
C446	1-164-004-11	CERAMIC CHIP 0.1μF	10% 25V				
C447	1-164-489-11	CERAMIC CHIP 0.22μF	10% 16V				
C448	1-107-823-11	CERAMIC CHIP 0.47μF	10% 16V				
C450	1-163-243-11	CERAMIC CHIP 47pF	5% 50V				
C451	1-104-664-11	ELECT 47μF	20% 25V				
C452	1-163-021-91	CERAMIC CHIP 0.01μF	10% 50V				
C453	1-163-021-91	CERAMIC CHIP 0.01μF	10% 50V				
C454	1-104-665-11	ELECT 100μF	20% 25V				
C457	1-163-021-91	CERAMIC CHIP 0.01μF	10% 50V				
C458	1-104-664-11	ELECT 47μF	20% 25V				
C459	1-107-930-91	ELECT 22μF	20% 100V				
C460	1-126-767-11	ELECT 1000μF	20% 16V				
C461	1-163-021-91	CERAMIC CHIP 0.01μF	10% 50V				
C462	1-163-021-91	CERAMIC CHIP 0.01μF	10% 50V				
C463	1-162-318-11	CERAMIC 0.001μF	10% 500V				
C464	1-104-664-11	ELECT 47μF	20% 25V				
C465	1-104-664-11	ELECT 47μF	20% 25V				
C466	1-104-664-11	ELECT 47μF	20% 25V				
C467	1-163-021-91	CERAMIC CHIP 0.01μF	10% 50V				
C468	1-126-933-11	ELECT 100μF	20% 16V				
C470	1-163-021-91	CERAMIC CHIP 0.01μF	10% 50V				
C478	1-115-350-51	CERAMIC 0.0047μF	2KV				
C481	1-163-021-91	CERAMIC CHIP 0.01μF	10% 50V				
C482	1-115-339-11	CERAMIC CHIP 0.1μF	10% 50V				
C483	1-115-339-11	CERAMIC CHIP 0.1μF	10% 50V				
C484	1-162-318-11	CERAMIC 0.001μF	10% 500V				
C485	1-107-652-11	ELECT 10μF	20% 250V				
C486	1-163-021-91	CERAMIC CHIP 0.01μF	10% 50V				
C487	1-104-664-11	ELECT 47μF	20% 25V				
C488	1-104-664-11	ELECT 47μF	20% 25V				
C489	1-164-004-11	CERAMIC CHIP 0.1μF	10% 25V				
<CONNECTOR>							
CN401*	1-564-521-11	PLUG, CONNECTOR 6P					
CN402*	1-564-522-11	PLUG, CONNECTOR 7P					
CN403*	1-564-525-11	PLUG, CONNECTOR 10P					
CN405*	1-564-522-11	PLUG, CONNECTOR 7P					
CN406*	1-766-179-11	PIN, CONNECTOR (PC BOARD) 2P					
CN407*	1-564-526-11	PLUG, CONNECTOR 11P					
						<DIODE>	
				D101	8-719-062-51	DIODE 1PS226-115	
				D102	8-719-062-51	DIODE 1PS226-115	
				D103	8-719-988-61	DIODE 1SS355TE-17	
				D105	8-719-052-12	DIODE 1SS376TE-17	
				D106	8-719-052-12	DIODE 1SS376TE-17	
				D107	8-719-052-12	DIODE 1SS376TE-17	
				D201	8-719-062-51	DIODE 1PS226-115	
				D202	8-719-062-51	DIODE 1PS226-115	
				D203	8-719-988-61	DIODE 1SS355TE-17	
				D205	8-719-052-12	DIODE 1SS376TE-17	
				D206	8-719-052-12	DIODE 1SS376TE-17	
				D207	8-719-052-12	DIODE 1SS376TE-17	
				D301	8-719-062-51	DIODE 1PS226-115	
				D302	8-719-062-51	DIODE 1PS226-115	
				D303	8-719-988-61	DIODE 1SS355TE-17	
				D305	8-719-052-12	DIODE 1SS376TE-17	
				D306	8-719-052-12	DIODE 1SS376TE-17	
				D307	8-719-052-12	DIODE 1SS376TE-17	
				D401	8-719-988-61	DIODE 1SS355TE-17	
				D402	8-719-976-99	ZENER DIODE DTZ-5.1B	
				D403	8-719-978-04	ZENER DIODE DTZ-TT11-3.3B	
				D405	8-719-988-61	DIODE 1SS355TE-17	
				D406	8-719-976-96	ZENER DIODE DTZ4.7C	
				D408	8-719-988-61	DIODE 1SS355TE-17	
				D409	8-719-988-61	DIODE 1SS355TE-17	
				D410	8-719-988-61	DIODE 1SS355TE-17	
				D411	8-719-062-51	DIODE 1PS226-115	
				<FERRITE BEAD>			
				FB101	1-216-295-91	SHORT	0
				FB201	1-216-295-91	SHORT	0
				FB301	1-216-295-91	SHORT	0
				FB401	1-412-911-11	FERRITE	1.1μH
				FB402	1-412-911-11	FERRITE	1.1μH
				FB403	1-412-911-11	FERRITE	1.1μH
				FB404	1-412-911-11	FERRITE	1.1μH
				FB405	1-412-911-11	FERRITE	1.1μH
				FB406	1-412-911-11	FERRITE	1.1μH
				<IC>			
				IC401	8-759-522-86	IC M52755FP-TP	
				IC402	8-759-468-63	IC M52722P	
				IC403	8-749-013-74	IC FA4111	
				IC404	8-759-566-26	IC LSC4380DW2AR2	
				IC405	8-759-502-82	IC LM324M	
				IC406	8-759-701-79	IC NJM7812FA	
				IC407	8-749-011-42	IC SI-3050F	
				IC409	8-759-502-82	IC LM324M	
				IC410	8-759-064-36	IC MB88346BPFV	

The components identified by shading and mark Δ are critical for safety. Replace only with part number specified.

Les composants identifiés par un trame et une marque Δ sont critiques pour la sécurité. Ne les remplacer que par une pièce portant le numéro spécifié.



REF.NO.	PART NO.	DESCRIPTION	REMARK	REF.NO.	PART NO.	DESCRIPTION	REMARK
		<COIL>		R109	1-216-107-00	RES,CHIP 270K	5% 1/10W
L101	1-412-478-11	INDUCTOR 0.15 μ H		R111	1-216-033-00	RES,CHIP 220	5% 1/10W
L102	1-412-478-11	INDUCTOR 0.15 μ H		R112	1-216-619-11	METAL CHIP 47	0.50%1/10W
L201	1-412-478-11	INDUCTOR 0.15 μ H		R113	1-216-009-91	RES,CHIP 22	5% 1/10W
L202	1-412-478-11	INDUCTOR 0.15 μ H		R114	1-216-035-00	RES,CHIP 270	5% 1/10W
L301	1-412-478-11	INDUCTOR 0.15 μ H		R115	1-216-035-00	RES,CHIP 270	5% 1/10W
L302	1-412-478-11	INDUCTOR 0.15 μ H		R116	1-216-017-91	RES,CHIP 47	5% 1/10W
L401	1-408-615-31	INDUCTOR 100 μ H		R117	1-216-065-91	RES,CHIP 4.7K	5% 1/10W
L402	1-412-529-17	INDUCTOR 22 μ H		R118	1-216-059-00	RES,CHIP 2.7K	5% 1/10W
L403	1-412-537-31	INDUCTOR 100 μ H		R119	1-216-009-91	RES,CHIP 22	5% 1/10W
L404	1-408-615-31	INDUCTOR 100 μ H		R120	1-216-097-91	RES,CHIP 100K	5% 1/10W
		<IC LINK>		R121	1-216-097-91	RES,CHIP 100K	5% 1/10W
PS401 Δ	1-533-590-31	LINK, IC (1A/90V AC, 60V DC)		R122	1-216-027-00	RES,CHIP 120	5% 1/10W
PS402 Δ	1-533-590-31	LINK, IC (1A/90V AC, 60V DC)		R123	1-216-027-00	RES,CHIP 120	5% 1/10W
		<TRANSISTOR>		R124	1-219-497-11	CARBON 22	5% 1/2W
Q101	8-729-112-65	TRANSISTOR 2SA1462-Y33		R125	1-216-091-00	RES,CHIP 56K	5% 1/10W
Q105	8-729-041-66	TRANSISTOR 2SC4015TV2		R126	1-216-097-91	RES,CHIP 100K	5% 1/10W
Q106	8-729-200-17	TRANSISTOR 2SA1091-O		R127	1-216-035-00	RES,CHIP 270	5% 1/10W
Q201	8-729-112-65	TRANSISTOR 2SA1462-Y33		R128	1-216-121-91	RES,CHIP 1M	5% 1/10W
Q202	8-729-112-65	TRANSISTOR 2SA1462-Y33		R129	1-216-121-91	RES,CHIP 1M	5% 1/10W
Q205	8-729-041-66	TRANSISTOR 2SC4015TV2		R130	1-216-097-91	RES,CHIP 100K	5% 1/10W
Q206	8-729-200-17	TRANSISTOR 2SA1091-O		R131	1-216-057-00	RES,CHIP 2.2K	5% 1/10W
Q301	8-729-112-65	TRANSISTOR 2SA1462-Y33		R132	1-216-035-00	RES,CHIP 270	5% 1/10W
Q305	8-729-041-66	TRANSISTOR 2SC4015TV2		R133	1-216-049-91	RES,CHIP 1K	5% 1/10W
Q306	8-729-200-17	TRANSISTOR 2SA1091-O		R134	1-216-097-91	RES,CHIP 100K	5% 1/10W
Q401	8-729-216-22	TRANSISTOR 2SA1162-G		R135	1-216-037-00	RES,CHIP 330	5% 1/10W
Q402	8-729-120-28	TRANSISTOR 2SC1623-L5L6		R136	1-216-097-91	RES,CHIP 100K	5% 1/10W
Q403	8-729-216-22	TRANSISTOR 2SA1162-G		R137	1-216-097-91	RES,CHIP 100K	5% 1/10W
Q404	8-729-029-06	TRANSISTOR DTC124EMA-T106		R139	1-216-073-00	RES,CHIP 10K	5% 1/10W
Q405	8-729-120-28	TRANSISTOR 2SC1623-L5L6		R140	1-216-129-00	RES,CHIP 2.2M	5% 1/10W
Q406	8-729-216-22	TRANSISTOR 2SA1162-G		R141	1-216-025-91	RES,CHIP 100	5% 1/10W
Q407	8-729-028-74	TRANSISTOR DTA114TMA-T106		R167	1-216-121-91	RES,CHIP 1M	5% 1/10W
Q408	8-729-216-22	TRANSISTOR 2SA1162-G		R201	1-215-395-00	METAL 82	1% 1/4W
Q409	8-729-216-22	TRANSISTOR 2SA1162-G		R202	1-216-025-91	RES,CHIP 100	5% 1/10W
Q410	8-729-032-61	TRANSISTOR 2SC5022-02		R203	1-215-395-00	METAL 82	1% 1/4W
Q411	8-729-216-22	TRANSISTOR 2SA1162-G		R204	1-216-025-91	RES,CHIP 100	5% 1/10W
Q412	8-729-216-22	TRANSISTOR 2SA1162-G		R205	1-216-017-91	RES,CHIP 47	5% 1/10W
Q413	8-729-216-22	TRANSISTOR 2SA1162-G		R206	1-216-017-91	RES,CHIP 47	5% 1/10W
Q414	8-729-216-22	TRANSISTOR 2SA1162-G		R208	1-216-099-00	RES,CHIP 120K	5% 1/10W
Q415	8-729-120-28	TRANSISTOR 2SC1623-L5L6		R209	1-216-107-00	RES,CHIP 270K	5% 1/10W
Q416	8-729-120-28	TRANSISTOR 2SC1623-L5L6		R211	1-216-033-00	RES,CHIP 220	5% 1/10W
Q417	8-729-216-22	TRANSISTOR 2SA1162-G		R212	1-216-619-11	METAL CHIP 47	0.50%1/10W
		<RESISTOR>		R213	1-216-009-91	RES,CHIP 22	5% 1/10W
R101	1-215-395-00	METAL 82	1% 1/4W	R214	1-216-035-00	RES,CHIP 270	5% 1/10W
R102	1-216-025-91	RES,CHIP 100	5% 1/10W	R215	1-216-035-00	RES,CHIP 270	5% 1/10W
R103	1-215-395-00	METAL 82	1% 1/4W	R216	1-216-017-91	RES,CHIP 47	5% 1/10W
R104	1-216-025-91	RES,CHIP 100	5% 1/10W	R217	1-216-065-91	RES,CHIP 4.7K	5% 1/10W
R105	1-216-017-91	RES,CHIP 47	5% 1/10W	R218	1-216-059-00	RES,CHIP 2.7K	5% 1/10W
R106	1-216-017-91	RES,CHIP 47	5% 1/10W	R219	1-216-009-91	RES,CHIP 22	5% 1/10W
R108	1-216-099-00	RES,CHIP 120K	5% 1/10W	R220	1-216-097-91	RES,CHIP 100K	5% 1/10W
				R221	1-216-097-91	RES,CHIP 100K	5% 1/10W
				R222	1-216-027-00	RES,CHIP 120	5% 1/10W
				R223	1-216-027-00	RES,CHIP 120	5% 1/10W
				R224	1-219-742-11	CARBON 47	5% 1/2W
				R225	1-216-091-00	RES,CHIP 56K	5% 1/10W
				R226	1-216-097-91	RES,CHIP 100K	5% 1/10W

GDM-F500/F500T9



REF.NO.	PART NO.	DESCRIPTION	REMARK	REF.NO.	PART NO.	DESCRIPTION	REMARK
R227	1-216-035-00	RES,CHIP	270 5% 1/10W	R401	1-216-073-00	RES,CHIP	10K 5% 1/10W
R228	1-216-121-91	RES,CHIP	1M 5% 1/10W	R402	1-216-105-91	RES,CHIP	220K 5% 1/10W
R229	1-216-121-91	RES,CHIP	1M 5% 1/10W	R403	1-216-105-91	RES,CHIP	220K 5% 1/10W
R230	1-216-097-91	RES,CHIP	100K 5% 1/10W	R404	1-216-065-91	RES,CHIP	4.7K 5% 1/10W
R231	1-216-057-00	RES,CHIP	2.2K 5% 1/10W	R406	1-216-049-91	RES,CHIP	1K 5% 1/10W
R232	1-216-035-00	RES,CHIP	270 5% 1/10W	R407	1-216-089-91	RES,CHIP	47K 5% 1/10W
R233	1-216-049-91	RES,CHIP	1K 5% 1/10W	R408	1-216-097-91	RES,CHIP	100K 5% 1/10W
R234	1-216-097-91	RES,CHIP	100K 5% 1/10W	R409	1-216-049-91	RES,CHIP	1K 5% 1/10W
R235	1-216-037-00	RES,CHIP	330 5% 1/10W	R410	1-216-049-91	RES,CHIP	1K 5% 1/10W
R236	1-216-097-91	RES,CHIP	100K 5% 1/10W	R411	1-216-065-91	RES,CHIP	4.7K 5% 1/10W
R237	1-216-097-91	RES,CHIP	100K 5% 1/10W	R412	1-216-053-00	RES,CHIP	1.5K 5% 1/10W
R239	1-216-073-00	RES,CHIP	10K 5% 1/10W	R413	1-216-065-91	RES,CHIP	4.7K 5% 1/10W
R240	1-216-129-00	RES,CHIP	2.2M 5% 1/10W	R414	1-216-105-91	RES,CHIP	220K 5% 1/10W
R241	1-216-025-91	RES,CHIP	100 5% 1/10W	R415	1-216-065-91	RES,CHIP	4.7K 5% 1/10W
R243	1-216-033-00	RES,CHIP	220 5% 1/10W	R416	1-216-081-00	RES,CHIP	22K 5% 1/10W
R267	1-216-121-91	RES,CHIP	1M 5% 1/10W	R417	1-216-081-00	RES,CHIP	22K 5% 1/10W
R301	1-215-395-00	METAL	82 1% 1/4W	R418	1-260-127-11	CARBON	220K 5% 1/2W
R302	1-216-025-91	RES,CHIP	100 5% 1/10W	R419	1-216-089-91	RES,CHIP	47K 5% 1/10W
R303	1-215-395-00	METAL	82 1% 1/4W	R421	1-216-097-91	RES,CHIP	100K 5% 1/10W
R304	1-216-025-91	RES,CHIP	100 5% 1/10W	R422	1-216-025-91	RES,CHIP	100 5% 1/10W
R305	1-216-017-91	RES,CHIP	47 5% 1/10W	R423	1-216-049-91	RES,CHIP	1K 5% 1/10W
R306	1-216-017-91	RES,CHIP	47 5% 1/10W	R424	1-216-025-91	RES,CHIP	100 5% 1/10W
R308	1-216-099-00	RES,CHIP	120K 5% 1/10W	R425	1-216-295-91	SHORT	0
R309	1-216-107-00	RES,CHIP	270K 5% 1/10W	R426	1-216-049-91	RES,CHIP	1K 5% 1/10W
R311	1-216-033-00	RES,CHIP	220 5% 1/10W	R427	1-216-025-91	RES,CHIP	100 5% 1/10W
R312	1-216-619-11	METAL CHIP	47 0.50% 1/10W	R428	1-216-025-91	RES,CHIP	100 5% 1/10W
R313	1-216-009-91	RES,CHIP	22 5% 1/10W	R429	1-216-049-91	RES,CHIP	1K 5% 1/10W
R314	1-216-035-00	RES,CHIP	270 5% 1/10W	R430	1-216-049-91	RES,CHIP	1K 5% 1/10W
R315	1-216-035-00	RES,CHIP	270 5% 1/10W	R431	1-216-049-91	RES,CHIP	1K 5% 1/10W
R316	1-216-017-91	RES,CHIP	47 5% 1/10W	R432	1-216-025-91	RES,CHIP	100 5% 1/10W
R317	1-216-065-91	RES,CHIP	4.7K 5% 1/10W	R433	1-216-073-00	RES,CHIP	10K 5% 1/10W
R318	1-216-059-00	RES,CHIP	2.7K 5% 1/10W	R434	1-216-065-91	RES,CHIP	4.7K 5% 1/10W
R319	1-216-009-91	RES,CHIP	22 5% 1/10W	R435	1-216-121-91	RES,CHIP	1M 5% 1/10W
R320	1-216-097-91	RES,CHIP	100K 5% 1/10W	R436	1-216-067-00	RES,CHIP	5.6K 5% 1/10W
R321	1-216-097-91	RES,CHIP	100K 5% 1/10W	R438	1-216-053-00	RES,CHIP	1.5K 5% 1/10W
R322	1-216-027-00	RES,CHIP	120 5% 1/10W	R439	1-216-053-00	RES,CHIP	1.5K 5% 1/10W
R323	1-216-027-00	RES,CHIP	120 5% 1/10W	R440	1-216-065-91	RES,CHIP	4.7K 5% 1/10W
R324	1-219-742-11	CARBON	47 5% 1/2W	R441	1-216-049-91	RES,CHIP	1K 5% 1/10W
R325	1-216-091-00	RES,CHIP	56K 5% 1/10W	R442	1-216-061-00	RES,CHIP	3.3K 5% 1/10W
R326	1-216-097-91	RES,CHIP	100K 5% 1/10W	R443	1-216-041-00	RES,CHIP	470 5% 1/10W
R327	1-216-035-00	RES,CHIP	270 5% 1/10W	R444	1-216-057-00	RES,CHIP	2.2K 5% 1/10W
R328	1-216-121-91	RES,CHIP	1M 5% 1/10W	R445	1-216-073-00	RES,CHIP	10K 5% 1/10W
R329	1-216-121-91	RES,CHIP	1M 5% 1/10W	R446	1-216-295-91	SHORT	0
R330	1-216-097-91	RES,CHIP	100K 5% 1/10W	R447	1-216-097-91	RES,CHIP	100K 5% 1/10W
R331	1-216-057-00	RES,CHIP	2.2K 5% 1/10W	R448	1-216-073-00	RES,CHIP	10K 5% 1/10W
R332	1-216-035-00	RES,CHIP	270 5% 1/10W	R449	1-216-105-91	RES,CHIP	220K 5% 1/10W
R333	1-216-049-91	RES,CHIP	1K 5% 1/10W	R450	1-216-105-91	RES,CHIP	220K 5% 1/10W
R334	1-216-097-91	RES,CHIP	100K 5% 1/10W	R453	1-216-057-00	RES,CHIP	2.2K 5% 1/10W
R335	1-216-037-00	RES,CHIP	330 5% 1/10W	R454	1-216-129-00	RES,CHIP	2.2M 5% 1/10W
R336	1-216-097-91	RES,CHIP	100K 5% 1/10W	R455	1-216-065-91	RES,CHIP	4.7K 5% 1/10W
R337	1-216-097-91	RES,CHIP	100K 5% 1/10W	R456	1-216-089-91	RES,CHIP	47K 5% 1/10W
R339	1-216-073-00	RES,CHIP	10K 5% 1/10W	R457	1-211-895-11	METAL	10M 10% 1/4W
R340	1-216-129-00	RES,CHIP	2.2M 5% 1/10W	R458	1-211-885-21	METAL	2.2M 5% 1W
R341	1-216-025-91	RES,CHIP	100 5% 1/10W	R459	1-211-895-11	METAL	10M 10% 1/4W
R367	1-216-121-91	RES,CHIP	1M 5% 1/10W	R461	1-249-441-11	CARBON	100K 5% 1/4W
R400	1-216-089-91	RES,CHIP	47K 5% 1/10W	R462	1-216-089-91	RES,CHIP	47K 5% 1/10W



Les composants identifiés par un tréma et une marque Δ sont critiques pour la sécurité. Ne les remplacer que par une pièce portant le numéro spécifié.

The components identified by shading and mark Δ are critical for safety. Replace only with part number specified.

REF.NO.	PART NO.	DESCRIPTION	REMARK	REF.NO.	PART NO.	DESCRIPTION	REMARK	
C629	1-107-674-91	ELECT	0.47 μ F 20% 450V	C926	1-115-516-11	FILM	0.33 μ F 5% 250V	
C630	1-164-004-11	CERAMIC CHIP	0.1 μ F 10% 25V	C927	1-163-009-11	CERAMIC CHIP	0.001 μ F 10% 50V	
C631	1-164-161-11	CERAMIC CHIP	0.0022 μ F 10% 50V	C928	1-104-665-11	ELECT	100 μ F 20% 25V	
C640	1-104-330-91	CERAMIC	470pF 10% 1KV	C929	1-136-187-11	FILM	0.047 μ F 10% 250V	
C641	1-104-330-91	CERAMIC	470pF 10% 1KV	C931	1-107-906-11	ELECT	10 μ F 20% 50V	
C642	1-136-171-00	FILM	0.33 μ F 5% 50V	C932	1-164-004-11	CERAMIC CHIP	0.1 μ F 10% 25V	
C643	1-136-171-00	FILM	0.33 μ F 5% 50V	C933	1-164-004-11	CERAMIC CHIP	0.1 μ F 10% 25V	
C644	1-104-330-91	CERAMIC	470pF 10% 1KV	C935	1-164-004-11	CERAMIC CHIP	0.1 μ F 10% 25V	
C645	1-136-167-00	FILM	0.15 μ F 5% 50V	C936	1-107-909-11	ELECT	47 μ F 20% 50V	
C646	1-136-167-00	FILM	0.15 μ F 5% 50V	C937	1-104-664-11	ELECT	47 μ F 20% 25V	
C647	1-129-719-00	FILM	0.027 μ F 5% 630V	C938	1-163-021-91	CERAMIC CHIP	0.01 μ F 10% 50V	
C660	1-107-910-11	ELECT	100 μ F 20% 50V			<CONNECTOR>		
C662	1-130-495-00	FILM	0.1 μ F 5% 50V			CN603*1-784-222-11	PIN, CONNECTOR (WITH PWB)	
C663	1-126-965-11	ELECT	22 μ F 20% 50V			CN604	1-691-960-11	PIN, CONNECTOR (PC BOARD) 3P
C670	1-137-370-11	FILM	0.01 μ F 5% 50V			CN605	1-785-294-11	PIN, CONNECTOR (PC BOARD) 3P
C671	1-107-966-51	ELECT	220 μ F 20% 250V			CN671*1-564-515-11	PLUG, CONNECTOR 12P	
C672	1-107-959-11	ELECT	3.3 μ F 20% 250V			CN672*1-564-510-11	PLUG, CONNECTOR 7P	
C673	1-107-935-11	ELECT	330 μ F 20% 100V			CN673*1-764-334-11	PLUG, CONNECTOR 11P	
C674	1-107-928-11	ELECT	4.7 μ F 20% 100V			CN690*1-564-508-11	PLUG, CONNECTOR 5P	
C675	1-107-890-11	ELECT	2200 μ F 20% 25V			CN901	1-764-101-11	PIN, CONNECTOR (PC BOARD) 2P
C676	1-107-888-11	ELECT	47 μ F 20% 25V				<DIODE>	
C677	1-107-890-11	ELECT	2200 μ F 20% 25V	D601	8-719-911-19	DIODE	1SS119-25	
C678	1-107-888-11	ELECT	47 μ F 20% 25V	D602 Δ	8-719-510-53	DIODE	D4SB60L	
C679	1-126-927-11	ELECT	2200 μ F 20% 10V	D603	8-719-110-57	ZENER DIODE	RD22ESB2	
C680	1-126-927-11	ELECT	2200 μ F 20% 10V	D604	8-719-911-19	DIODE	1SS119-25	
C681	1-126-965-11	ELECT	22 μ F 20% 50V	D605	8-719-911-19	DIODE	1SS119-25	
C683	1-164-646-11	CERAMIC	2200pF 10% 500V	D606	8-719-110-53	ZENER DIODE	RD20ESB2	
C684	1-137-370-11	FILM	0.01 μ F 5% 50V	D607	8-719-911-19	DIODE	1SS119-25	
C685	1-107-909-11	ELECT	47 μ F 20% 50V	D608	8-719-911-19	DIODE	1SS119-25	
C693	1-130-495-00	FILM	0.1 μ F 5% 50V	D609	8-719-911-19	DIODE	1SS119-25	
C696	1-111-025-51	ELECT	0.0068F 20% 10V	D610 Δ	8-719-510-53	DIODE	D4SB60L	
C901	1-126-961-11	ELECT	2.2 μ F 20% 50V	D611	8-719-029-04	DIODE	D5L60	
C902	1-164-004-11	CERAMIC CHIP	0.1 μ F 10% 25V	D612	8-719-304-63	DIODE	RM11C	
C903	1-164-004-11	CERAMIC CHIP	0.1 μ F 10% 25V	D613	8-719-110-49	ZENER DIODE	RD18ESB2	
C904	1-163-243-11	CERAMIC CHIP	47pF 5% 50V	D614	8-719-977-28	ZENER DIODE	DTZ10B	
C905	1-163-145-00	CERAMIC CHIP	0.0015 μ F 5% 50V	D615	8-719-121-26	ZENER DIODE	RD9.1ESL2	
C906	1-163-021-91	CERAMIC CHIP	0.01 μ F 10% 50V	D616	8-719-068-00	DIODE	ERC04-06SE	
C907	1-163-275-11	CERAMIC CHIP	0.001 μ F 5% 50V	D617	8-719-068-00	DIODE	ERC04-06SE	
C908	1-163-017-00	CERAMIC CHIP	0.0047 μ F 10% 50V	D618	8-719-109-97	ZENER DIODE	RD6.8ESB2	
C909	1-164-004-11	CERAMIC CHIP	0.1 μ F 10% 25V	D660	8-719-059-23	DIODE	P6KE200AG23	
C910	1-126-934-11	ELECT	220 μ F 20% 16V	D661	8-719-979-64	DIODE	UF4005PKG23	
C911	1-163-259-91	CERAMIC CHIP	220pF 5% 50V	D662	8-719-058-91	DIODE	AG01A-V0	
C912	1-106-383-00	MYLAR	0.047 μ F 10% 200V	D663	8-719-110-08	ZENER DIODE	RD8.2ESB2	
C913	1-126-967-11	ELECT	47 μ F 20% 50V	D670	8-719-064-49	DIODE	D4SBL40	
C914	1-104-760-11	CERAMIC CHIP	0.047 μ F 10% 50V	D671	8-719-510-64	DIODE	S2LA20F	
C915	1-119-748-11	ELECT	33 μ F 20% 400V	D672	8-719-052-91	DIODE	D4SBS4-F	
C916	1-162-114-00	CERAMIC	0.0047 μ F 2KV	D673	8-719-022-97	DIODE	D2S4MF	
C917	1-163-009-11	CERAMIC CHIP	0.001 μ F 10% 50V	D674	8-719-022-97	DIODE	D2S4MF	
C918	1-164-004-11	CERAMIC CHIP	0.1 μ F 10% 25V	D677	8-719-911-19	DIODE	1SS119-25	
C919	1-137-368-11	FILM	0.0047 μ F 5% 50V	D678	8-719-911-19	DIODE	1SS119-25	
C920	1-117-624-11	FILM	1600pF 3% 1.2KV					
C921	1-137-372-11	FILM	0.022 μ F 5% 50V					
C922	1-106-228-00	MYLAR	0.22 μ F 10% 100V					
C923	1-106-220-00	MYLAR	0.1 μ F 10% 100V					
C924	1-106-355-12	MYLAR	0.0033 μ F 10% 200V					
C925	1-106-220-00	MYLAR	0.1 μ F 10% 100V					

The components identified by shading and mark Δ are critical for safety. Replace only with part number specified.

Les composants identifiés par un trame et une marque Δ sont critiques pour la sécurité. Ne les remplacer que par une pièce portant le numéro spécifié.



REF.NO.	PART NO.	DESCRIPTION	REMARK	REF.NO.	PART NO.	DESCRIPTION	REMARK
D681	8-719-911-19	DIODE 1SS119-25		L902	1-406-660-41	INDUCTOR 15 μ H	
D682	8-719-510-64	DIODE S2LA20F				<PHOTO COUPLER>	
D683	8-719-911-19	DIODE 1SS119-25		PH601	8-749-010-64	PHOTO COUPLER PC123F2	
D684	8-719-110-57	ZENER DIODE RD22ESB2		PH660	8-749-010-64	PHOTO COUPLER PC123F2	
D692	8-719-911-19	DIODE 1SS119-25				<IC LINK>	
D694	8-719-510-41	DIODE D10SC9M		PS670 Δ 1-533-593-31	LINK, IC (2A/90V AC, 60V DC)		
D902	8-719-158-49	ZENER DIODE RD12SB2		PS671 Δ 1-533-593-31	LINK, IC (2A/90V AC, 60V DC)		
D903	8-719-911-19	DIODE 1SS119-25		PS673 Δ 1-533-593-31	LINK, IC (2A/90V AC, 60V DC)		
D904	8-719-018-82	DIODE RGP02-20EL6394		PS674 Δ 1-533-593-31	LINK, IC (2A/90V AC, 60V DC)		
D906	8-719-911-19	DIODE 1SS119-25		PS901 Δ 1-533-592-31	LINK, IC (1.6A/90V AC, 60V DC)		
D907	8-719-911-19	DIODE 1SS119-25				<TRANSISTOR>	
D908	8-719-911-19	DIODE 1SS119-25		Q601	8-729-026-49	TRANSISTOR 2SA1037AK-T146-R	
D909	8-719-977-28	ZENER DIODE DTZ10B		Q602	8-729-120-28	TRANSISTOR 2SC1623-L5L6	
D910	8-719-110-36	ZENER DIODE RD13ESB2		Q603	8-729-120-28	TRANSISTOR 2SC1623-L5L6	
D911	8-719-977-69	ZENER DIODE DTZ24B		Q604	8-729-026-49	TRANSISTOR 2SA1037AK-T146-R	
D912	8-719-110-46	ZENER DIODE RD16ESB3		Q605	8-729-120-28	TRANSISTOR 2SC1623-L5L6	
D913	8-719-979-58	DIODE EGP10D		Q606	8-729-041-66	TRANSISTOR 2SC4015TV2	
D914	8-719-110-46	ZENER DIODE RD16ESB3		Q607	8-729-041-66	TRANSISTOR 2SC4015TV2	
D915	8-719-911-19	DIODE 1SS119-25		Q608	8-729-026-49	TRANSISTOR 2SA1037AK-T146-R	
D916	8-719-977-81	ZENER DIODE DTZ33B		Q609	8-729-045-03	TRANSISTOR 2SK2647-01MR-F91	
D917	8-719-063-89	DIODE YG911S3R		Q610	8-729-041-65	TRANSISTOR 2SK2195F04	
D918	8-719-158-49	ZENER DIODE RD12SB2		Q611	8-729-026-49	TRANSISTOR 2SA1037AK-T146-R	
D919	8-719-109-85	ZENER DIODE RD5.1ESB2		Q612	8-729-900-53	TRANSISTOR DTC114EK	
D920	8-719-018-82	DIODE RGP02-20EL6394		Q640	8-729-041-12	TRANSISTOR MX0841AB-F	
		<FUSE>		Q660	8-729-119-78	TRANSISTOR 2SC2785-HFE	
F601	Δ 1-576-233-11	FUSE (H.B.C.) (6.3A/250V)		Q680	8-729-620-05	TRANSISTOR 2SC2603-EF	
		<FERRITE BEAD>		Q681	8-729-230-45	TRANSISTOR 2SC2458-YGR	
FB610	1-410-396-41	FERRITE 0.45 μ H		Q682	8-729-119-76	TRANSISTOR 2SA1175-HFE	
FB611	1-410-396-41	FERRITE 0.45 μ H		Q683	8-729-119-76	TRANSISTOR 2SA1175-HFE	
FB612	1-410-396-41	FERRITE 0.45 μ H		Q690	8-729-119-78	TRANSISTOR 2SC2785-HFE	
FB901	1-410-397-21	FERRITE 1.1 μ H		Q901	8-729-120-28	TRANSISTOR 2SC1623-L5L6	
FB902	1-410-397-21	FERRITE 1.1 μ H		Q902	8-729-033-25	TRANSISTOR DTC114GKA	
		<IC>		Q903	8-729-901-97	TRANSISTOR 2SA1036K-Q	
IC601	8-759-482-62	IC MC33262P		Q904	8-729-120-28	TRANSISTOR 2SC1623-L5L6	
IC602	8-759-535-32	IC FA13842P		Q905	8-729-035-54	TRANSISTOR 2SJ449	
IC630	8-749-013-03	IC DM-60		Q906	8-729-033-91	TRANSISTOR 2SK1120LBSOY2	
IC691	8-759-140-85	IC μ PC1093J		Q907	8-729-033-26	TRANSISTOR DTA114GKAT146	
IC901 Δ	8-759-467-70	IC BA9756FS-E2		Q908	8-729-033-25	TRANSISTOR DTC114GKA	
IC902	8-759-510-73	IC BA10393F-E2				<RESISTOR>	
		<COIL>		R601 Δ	1-220-825-91	CARBON 330K 5% 1/2W	
L610	1-416-409-11	COIL, CHOKE		R602	1-260-079-11	CARBON 22 5% 1/2W	
L611	1-411-674-11	COIL, CHOKE 68 μ H		R603	1-216-025-91	RES,CHIP 100 5% 1/10W	
L670	1-412-529-11	INDUCTOR 22 μ H		R604	1-260-085-11	CARBON 68 5% 1/2W	
L671	1-412-529-11	INDUCTOR 22 μ H		R605	1-216-073-00	RES,CHIP 10K 5% 1/10W	
L672	1-412-529-11	INDUCTOR 22 μ H		R606	1-216-041-00	RES,CHIP 470 5% 1/10W	
L673	1-412-529-11	INDUCTOR 22 μ H		R607	1-216-673-11	METAL CHIP 8.2K 0.50%1/10W	
L691	1-412-529-11	INDUCTOR 22 μ H		R608	1-216-073-00	RES,CHIP 10K 5% 1/10W	
L901	1-412-537-31	INDUCTOR 100 μ H		R609	1-216-073-00	RES,CHIP 10K 5% 1/10W	
				R610	1-216-383-11	METAL OXIDE 0.33 5% 3W F	

GDM-F500/F500T9



REF.NO.	PART NO.	DESCRIPTION	REMARK	REF.NO.	PART NO.	DESCRIPTION	REMARK
R611	1-216-383-11	METAL OXIDE	0.33 5% 3W F	R672	1-216-049-91	RES,CHIP	1K 5% 1/10W
R612	1-215-477-00	METAL	220K 1% 1/4W	R673	1-249-413-11	CARBON	470 5% 1/4W F
R613	1-215-477-00	METAL	220K 1% 1/4W	R674	1-249-377-11	CARBON	0.47 5% 1/4W F
R614	1-215-473-00	METAL	150K 1% 1/4W	R675	1-260-292-11	CARBON	1 5% 1/2W
R615	1-215-473-00	METAL	150K 1% 1/4W	R676	1-249-413-11	CARBON	470 5% 1/4W
R616	1-215-473-00	METAL	150K 1% 1/4W	R677	1-216-097-91	RES,CHIP	100K 5% 1/10W
R617	1-215-481-00	METAL	330K 1% 1/4W	R678	1-216-081-00	RES,CHIP	22K 5% 1/10W
R618	1-215-477-00	METAL	220K 1% 1/4W	R679	1-216-677-11	METAL CHIP	12K 0.50%1/10W
R619	1-215-485-00	METAL	470K 1% 1/4W	R680	1-216-057-00	RES,CHIP	2.2K 5% 1/10W
R620	1-215-485-00	METAL	470K 1% 1/4W	R681	1-216-049-91	RES,CHIP	1K 5% 1/10W
R621	1-215-481-00	METAL	330K 1% 1/4W	R682	1-216-065-91	RES,CHIP	4.7K 5% 1/10W
R622	1-216-049-91	RES,CHIP	1K 5% 1/10W	R683	1-216-025-91	RES,CHIP	100 5% 1/10W
R623	1-216-651-11	METAL CHIP	1K 0.50%1/10W	R684	1-216-073-00	RES,CHIP	10K 5% 1/10W
R624	1-216-671-11	METAL CHIP	6.8K 0.50%1/10W	R685	1-249-417-11	CARBON	1K 5% 1/4W
R625	1-249-389-11	CARBON	4.7 5% 1/4W	R686	1-216-049-91	RES,CHIP	1K 5% 1/10W
R626	1-249-429-11	CARBON	10K 5% 1/4W	R687	1-216-677-11	METAL CHIP	12K 0.50%1/10W
R627	1-215-479-00	METAL	270K 1% 1/4W	R688	1-216-073-00	RES,CHIP	10K 5% 1/10W
R628	1-215-481-00	METAL	330K 1% 1/4W	R689	1-216-065-91	RES,CHIP	4.7K 5% 1/10W
R629	1-215-461-00	METAL	47K 1% 1/4W	R690	1-216-465-11	METAL OXIDE	27K 5% 2W F
R630	1-216-089-91	RES,CHIP	47K 5% 1/10W	R691	1-247-863-91	CARBON	22K 5% 1/4W
R631	1-247-807-31	CARBON	100 5% 1/4W	R692	1-260-085-11	CARBON	68 5% 1/2W
R632	1-216-073-00	RES,CHIP	10K 5% 1/10W	R693	1-216-065-91	RES,CHIP	4.7K 5% 1/10W
R633	1-215-481-00	METAL	330K 1% 1/4W	R694	1-216-073-00	RES,CHIP	10K 5% 1/10W
R634	1-216-073-00	RES,CHIP	10K 5% 1/10W	R695	1-249-443-11	CARBON	0.47 5% 1/4W F
R635	1-216-089-91	RES,CHIP	47K 5% 1/10W	R696	1-215-485-00	METAL	470K 1% 1/4W
R636	1-216-093-91	RES,CHIP	68K 5% 1/10W	R697	1-215-485-00	METAL	470K 1% 1/4W
R637	1-216-073-00	RES,CHIP	10K 5% 1/10W	R698	1-215-485-00	METAL	470K 1% 1/4W
R638	1-216-675-11	METAL CHIP	10K 0.50%1/10W	R699	1-216-097-91	RES,CHIP	100K 5% 1/10W
R640	1-202-933-61	FUSIBLE	0.1 10% 1/2W F	R901	1-216-065-91	RES,CHIP	4.7K 5% 1/10W
R641	1-218-642-11	METAL OXIDE	100K 5% 1W F	R902	1-216-097-91	RES,CHIP	100K 5% 1/10W
R642	1-218-642-11	METAL OXIDE	100K 5% 1W F	R903	1-211-791-11	FUSIBLE	220 5% 1/4W F
R643	1-216-097-91	RES,CHIP	100K 5% 1/10W	R904	1-216-073-00	RES,CHIP	10K 5% 1/10W
R644	1-260-135-11	CARBON	1M 5% 1/2W	R905	1-216-061-00	RES,CHIP	3.3K 5% 1/10W
R645	1-260-135-11	CARBON	1M 5% 1/2W	R906	1-216-109-00	RES,CHIP	330K 5% 1/10W
R646	1-216-113-00	RES,CHIP	470K 5% 1/10W	R907	1-216-065-91	RES,CHIP	4.7K 5% 1/10W
R647	1-216-097-91	RES,CHIP	100K 5% 1/10W	R908	1-249-397-11	CARBON	22 5% 1/4W F
R648	1-216-353-00	METAL OXIDE	2.2 5% 1W F	R909	1-216-073-00	RES,CHIP	10K 5% 1/10W
R649	1-218-642-11	METAL OXIDE	100K 5% 1W F	R910	1-216-397-11	METAL OXIDE	4.7 5% 3W F
R650	1-218-642-11	METAL OXIDE	100K 5% 1W F	R911	1-216-081-00	RES,CHIP	22K 5% 1/10W
R651	1-216-353-00	METAL OXIDE	2.2 5% 1W F	R912	1-216-057-00	RES,CHIP	2.2K 5% 1/10W
R653	1-247-895-91	CARBON	470K 5% 1/4W	R913	1-216-025-91	RES,CHIP	100 5% 1/10W
R654	1-216-465-11	METAL OXIDE	27K 5% 2W F	R914	1-216-073-00	RES,CHIP	10K 5% 1/10W
R655	1-216-113-00	RES,CHIP	470K 5% 1/10W	R915	1-216-065-91	RES,CHIP	4.7K 5% 1/10W
R656	1-216-069-00	RES,CHIP	6.8K 5% 1/10W	R916	1-216-033-00	RES,CHIP	220 5% 1/10W
R657	1-216-073-00	RES,CHIP	10K 5% 1/10W	R917	1-249-397-11	CARBON	22 5% 1/4W F
R658	1-216-671-11	METAL CHIP	6.8K 0.50%1/10W	R918	1-216-033-00	RES,CHIP	220 5% 1/10W
R659	1-216-685-11	METAL CHIP	27K 0.50%1/10W	R919	1-219-727-11	METAL	68 5% 10W
R660	1-216-081-00	RES,CHIP	22K 5% 1/10W	R920	1-249-389-11	CARBON	4.7 5% 1/4W F
R661	1-249-387-11	CARBON	3.3 5% 1/4W F	R921	1-219-748-11	CARBON	4.7K 5% 1/2W
R662	1-216-073-00	RES,CHIP	10K 5% 1/10W	R922	1-216-073-00	RES,CHIP	10K 5% 1/10W
R663	1-216-073-00	RES,CHIP	10K 5% 1/10W	R923	1-216-655-11	METAL CHIP	1.5K 0.50%1/10W
R664	1-216-097-91	RES,CHIP	100K 5% 1/10W	R924	1-220-825-11	CARBON	330K 5% 1/2W
R669	1-216-081-00	RES,CHIP	22K 5% 1/10W	R925	1-216-073-00	RES,CHIP	10K 5% 1/10W
R670	1-216-065-91	RES,CHIP	4.7K 5% 1/10W	R926	1-216-025-91	RES,CHIP	100 5% 1/10W
R671	1-216-113-00	RES,CHIP	470K 5% 1/10W	R927	1-216-073-00	RES,CHIP	10K 5% 1/10W
				R928	1-216-655-11	METAL CHIP	1.5K 0.50%1/10W

GDM-F500/F500T9



REF.NO.	PART NO.	DESCRIPTION	REMARK	REF.NO.	PART NO.	DESCRIPTION	REMARK
C049	1-163-137-00	CERAMIC CHIP 680pF	5% 50V	C511	1-117-398-11	ELECT 33μF	20% 250V
C050	1-163-809-11	CERAMIC CHIP 0.047μF	10% 25V	C512	1-104-666-11	ELECT 220μF	20% 25V
C051	1-126-960-11	ELECT 1μF	20% 50V	C513	1-163-017-00	CERAMIC CHIP 0.0047μF	10% 50V
C052	1-163-809-11	CERAMIC CHIP 0.047μF	10% 25V	C514	1-163-021-91	CERAMIC CHIP 0.01μF	10% 50V
C054	1-126-963-11	ELECT 4.7μF	20% 50V	C515	1-104-666-11	ELECT 220μF	20% 25V
C055	1-126-963-11	ELECT 4.7μF	20% 50V	C516	1-130-495-00	FILM 0.1μF	5% 50V
C056	1-163-809-11	CERAMIC CHIP 0.047μF	10% 25V	C517	1-104-574-11	CERAMIC 0.0047μF	10% 2KV
C057	1-104-664-11	ELECT 47μF	20% 25V	C518	1-125-924-11	FILM 3900pF	3% 1.8KV
C058	1-126-964-11	ELECT 10μF	20% 50V	C519	1-107-444-11	CERAMIC 100pF	5% 2KV
C059	1-163-021-91	CERAMIC CHIP 0.01μF	10% 50V	C520	1-117-948-91	FILM 1500pF	5% 630V
C060	1-126-964-11	ELECT 10μF	20% 50V	C521	1-107-597-11	CERAMIC 22pF	5% 500V
C061	1-163-021-91	CERAMIC CHIP 0.01μF	10% 50V	C522	1-107-444-11	CERAMIC 100pF	5% 2KV
C062	1-164-004-11	CERAMIC CHIP 0.1μF	10% 25V	C523	1-137-370-11	FILM 0.01μF	5% 50V
C063	1-130-495-00	FILM 0.1μF	5% 50V	C524	1-113-694-11	FILM 0.056μF	5% 400V
C065	1-126-965-11	ELECT 22μF	20% 50V	C525	1-107-846-11	FILM 0.1μF	5% 250V
C066	1-163-021-91	CERAMIC CHIP 0.01μF	10% 50V	C526	1-115-514-11	FILM 0.22μF	5% 250V
C067	1-163-243-11	CERAMIC CHIP 47pF	5% 50V	C527	1-115-517-11	FILM 0.39μF	5% 250V
C068	1-126-964-11	ELECT 10μF	20% 50V	C528	1-115-521-11	FILM 0.82μF	5% 250V
C069	1-163-021-91	CERAMIC CHIP 0.01μF	10% 50V	C529	1-107-683-11	ELECT 2.2μF	0 250V
C070	1-163-021-91	CERAMIC CHIP 0.01μF	10% 50V	C530	1-163-021-91	CERAMIC CHIP 0.01μF	10% 50V
C071	1-163-021-91	CERAMIC CHIP 0.01μF	10% 50V	C531	1-163-021-91	CERAMIC CHIP 0.01μF	10% 50V
C072	1-126-960-11	ELECT 1μF	20% 50V	C532	1-163-021-91	CERAMIC CHIP 0.01μF	10% 50V
C074	1-163-009-11	CERAMIC CHIP 0.001μF	10% 50V	C533	1-163-021-91	CERAMIC CHIP 0.01μF	10% 50V
C075	1-163-021-91	CERAMIC CHIP 0.01μF	10% 50V	C534	1-163-021-91	CERAMIC CHIP 0.01μF	10% 50V
C076	1-163-809-11	CERAMIC CHIP 0.047μF	10% 25V	C535	1-163-021-91	CERAMIC CHIP 0.01μF	10% 50V
C077	1-164-004-11	CERAMIC CHIP 0.1μF	10% 25V	C536	1-104-665-11	ELECT 100μF	20% 25V
C078	1-164-004-11	CERAMIC CHIP 0.1μF	10% 25V	C537	1-115-523-21	FILM 1.2μF	5% 250V
C079	1-104-664-11	ELECT 47μF	20% 25V	C538	1-125-979-11	FILM 0.3μF	5% 400V
C080	1-104-664-11	ELECT 47μF	20% 25V	C539	1-107-651-11	ELECT 4.7μF	20% 250V
C081	1-163-021-91	CERAMIC CHIP 0.01μF	10% 50V	C540	1-106-343-00	MYLAR 0.001μF	10% 200V
C082	1-126-964-11	ELECT 10μF	20% 50V	C541	1-163-243-11	CERAMIC CHIP 47pF	5% 50V
C083	1-104-664-11	ELECT 47μF	20% 25V	C542	1-163-243-11	CERAMIC CHIP 47pF	5% 50V
C084	1-164-004-11	CERAMIC CHIP 0.1μF	10% 25V	C544	1-137-368-11	FILM 0.0047μF	5% 50V
C085	1-130-495-00	FILM 0.1μF	5% 50V	C545	1-104-664-11	ELECT 47μF	20% 25V
C086	1-126-964-11	ELECT 10μF	20% 50V	C547	1-104-664-11	ELECT 47μF	20% 25V
C087	1-164-004-11	CERAMIC CHIP 0.1μF	10% 25V	C549	1-163-021-91	CERAMIC CHIP 0.01μF	10% 50V
C088	1-163-251-11	CERAMIC CHIP 100pF	5% 50V	C550	1-163-021-91	CERAMIC CHIP 0.01μF	10% 50V
C089	1-163-251-11	CERAMIC CHIP 100pF	5% 50V	C551	1-163-009-11	CERAMIC CHIP 0.001μF	10% 50V
C090	1-109-982-11	CERAMIC CHIP 1μF	10% 10V	C553	1-126-963-11	ELECT 4.7μF	20% 50V
C092	1-163-021-91	CERAMIC CHIP 0.01μF	10% 50V	C554	1-163-037-11	CERAMIC CHIP 0.022μF	10% 50V
C093	1-126-964-11	ELECT 10μF	20% 50V	C555	1-163-037-11	CERAMIC CHIP 0.022μF	10% 50V
C096	1-163-021-91	CERAMIC CHIP 0.01μF	10% 50V	C556	1-163-009-11	CERAMIC CHIP 0.001μF	10% 50V
C097	1-163-021-91	CERAMIC CHIP 0.01μF	10% 50V	C559	1-162-134-11	CERAMIC 470pF	10% 2KV
C098	1-163-021-91	CERAMIC CHIP 0.01μF	10% 50V	C560	1-163-021-91	CERAMIC CHIP 0.01μF	10% 50V
C099	1-164-004-11	CERAMIC CHIP 0.1μF	10% 25V	C561	1-136-173-00	FILM 0.47μF	5% 50V
C501	1-107-888-11	ELECT 47μF	20% 25V	C562	1-163-021-91	CERAMIC CHIP 0.01μF	10% 50V
C502	1-163-259-91	CERAMIC CHIP 220pF	5% 50V	C564	1-126-963-11	ELECT 4.7μF	20% 50V
C503	1-136-169-00	FILM 0.22μF	5% 50V	C565	1-125-925-11	FILM MELF 0.027μF	5% 400V
C504	1-137-605-11	FILM 0.01μF	10% 250V	C569	1-125-979-11	FILM 0.3μF	5% 400V
C505	1-163-251-11	CERAMIC CHIP 100pF	5% 50V	C701	1-104-664-11	ELECT 47μF	20% 25V
C506	1-136-169-00	FILM 0.22μF	5% 50V	C702	1-130-495-00	FILM 0.1μF	5% 50V
C507	1-136-173-00	FILM 0.47μF	5% 50V	C703	1-128-560-11	ELECT 22μF	20% 100V
C508	1-163-037-11	CERAMIC CHIP 0.022μF	10% 50V	C705	1-126-942-61	ELECT 1000μF	20% 25V
C509	1-111-063-11	ELECT 470μF	20% 25V	C706	1-163-021-91	CERAMIC CHIP 0.01μF	10% 50V
C510	1-137-368-11	FILM 0.0047μF	5% 50V	C707	1-163-021-91	CERAMIC CHIP 0.01μF	10% 50V
				C709	1-130-495-00	FILM 0.1μF	5% 50V

The components identified by shading and mark Δ are critical for safety. Replace only with part number specified.

Les composants identifiés par un trame et une marque Δ sont critiques pour la sécurité. Ne les remplacer que par une pièce portant le numéro spécifié.



REF.NO.	PART NO.	DESCRIPTION	REMARK	REF.NO.	PART NO.	DESCRIPTION	REMARK
C710	1-163-019-00	CERAMIC CHIP 0.0068 μ F	10% 50V	D006	8-719-510-02	DIODE D1NS4	
C711	1-126-949-11	ELECT 220 μ F	20% 35V	D009	8-719-976-99	ZENER DIODE DTZ5.1B	
C712	1-106-228-00	MYLAR 0.22 μ F	10% 100V	D010	8-719-976-99	ZENER DIODE DTZ5.1B	
C713	1-126-942-61	ELECT 1000 μ F	20% 25V	D012	8-719-062-51	DIODE 1PS226-115	
C714	1-104-664-11	ELECT 47 μ F	20% 25V	D013	8-719-062-51	DIODE 1PS226-115	
C719	1-128-562-11	ELECT 47 μ F	20% 100V	D014	8-719-062-51	DIODE 1PS226-115	
C720	1-162-134-11	CERAMIC 470pF	10% 2KV	D015	8-719-062-51	DIODE 1PS226-115	
C721	1-126-964-11	ELECT 10 μ F	20% 50V	D016	8-719-062-51	DIODE 1PS226-115	
C735	1-130-495-00	FILM 0.1 μ F	5% 50V	D017	8-719-801-78	DIODE 1SS184	
C746	1-163-009-11	CERAMIC CHIP 0.001 μ F	10% 50V	D018	8-719-801-78	DIODE 1SS184	
C747	1-163-021-91	CERAMIC CHIP 0.01 μ F	10% 50V	D019	8-719-062-51	DIODE 1PS226-115	
C751	1-163-021-91	CERAMIC CHIP 0.01 μ F	10% 50V	D020	8-719-062-51	DIODE 1PS226-115	
C920	1-163-009-11	CERAMIC CHIP 0.001 μ F	10% 50V	D025	8-719-976-99	ZENER DIODE DTZ5.1B	
C1003	1-163-021-91	CERAMIC CHIP 0.01 μ F	10% 50V	D026	8-719-062-51	DIODE 1PS226-115	
C1004	1-163-021-91	CERAMIC CHIP 0.01 μ F	10% 50V	D027	8-719-062-51	DIODE 1PS226-115	
C1005	1-163-021-91	CERAMIC CHIP 0.01 μ F	10% 50V	D028	8-719-062-51	DIODE 1PS226-115	
C1007	1-163-021-91	CERAMIC CHIP 0.01 μ F	10% 50V	D029	8-719-062-51	DIODE 1PS226-115	
C1008	1-163-021-91	CERAMIC CHIP 0.01 μ F	10% 50V	D032	8-719-976-99	ZENER DIODE DTZ5.1B	
C1009	1-126-960-11	ELECT 1 μ F	20% 50V	D035	8-719-801-78	DIODE 1SS184	
C1015	1-164-004-11	CERAMIC CHIP 0.1 μ F	10% 25V	D050	8-719-404-49	DIODE MA111	
C1019	1-104-664-11	ELECT 47 μ F	20% 25V	D501	8-719-977-40	ZENER DIODE DTZ13B	
C1023	1-163-021-91	CERAMIC CHIP 0.01 μ F	10% 50V	D502	8-719-063-89	DIODE YG911S3R	
C1024	1-104-664-11	ELECT 47 μ F	20% 25V	D503	8-719-404-49	DIODE MA111	
C1025	1-164-004-11	CERAMIC CHIP 0.1 μ F	10% 25V	D504	8-719-984-73	DIODE SB560	
C1026	1-164-004-11	CERAMIC CHIP 0.1 μ F	10% 25V	D505	8-719-028-72	DIODE RGP02-17EL-6433	
C1028	1-164-004-11	CERAMIC CHIP 0.1 μ F	10% 25V	D506	8-719-911-19	DIODE 1SS119-25	
C1029	1-164-004-11	CERAMIC CHIP 0.1 μ F	10% 25V	D507	8-719-911-19	DIODE 1SS119-25	
C1030	1-104-664-11	ELECT 47 μ F	20% 25V	D508	8-719-109-85	ZENER DIODE RD5.1ESB2	
C1501	1-163-021-91	CERAMIC CHIP 0.01 μ F	10% 50V	D509	8-719-911-19	DIODE 1SS119-25	
C1502	1-117-722-11	ELECT 2200 μ F	20% 10V	D510	8-719-951-30	DIODE ERA91-02	
C1503	1-163-001-11	CERAMIC CHIP 220pF	10% 50V	D511	8-719-911-19	DIODE 1SS119-25	
		<CONNECTOR>		D513	8-719-404-49	DIODE MA111	
CN501*	1-564-513-11	PLUG, CONNECTOR 10P		D514	8-719-109-93	ZENER DIODE RD6.2ESB2	
CN502*	1-564-512-11	PLUG, CONNECTOR 9P		D516	8-719-105-99	ZENER DIODE RD6.2M-B1	
CN503*	1-564-515-11	PLUG, CONNECTOR 12P		D517	8-719-105-99	DIODE RD6.2M-B1	
CN504*	1-564-514-11	PLUG, CONNECTOR 11P		D518	8-719-404-49	DIODE MA111	
CN505*	1-508-879-11	BASE POST		D519	8-719-066-36	DIODE FMQ-G5GS	
CN506	1-564-513-11	PLUG, CONNECTOR 10P		D520	8-719-510-02	DIODE D1NS4	
CN507*	1-695-207-21	PIN, CONNECTOR (PC BOARD) 6P		D521	8-719-404-49	DIODE MA111	
CN508*	1-778-955-11	PIN, CONNECTOR (PC BOARD) 10P		D701	8-719-158-15	ZENER DIODE RD5.6SB	
CN509	1-564-505-11	PLUG, CONNECTOR 2P		D702	8-719-911-19	DIODE 1SS119-25	
CN510*	1-564-507-11	PLUG, CONNECTOR 4P		D703	8-719-911-19	DIODE 1SS119-25	
CN511*	1-564-514-11	PLUG, CONNECTOR 11P		D704	8-719-404-49	DIODE MA111	
CN512*	1-564-512-11	PLUG, CONNECTOR 9P		D705	8-719-404-49	DIODE MA111	
CN513*	1-564-506-11	PLUG, CONNECTOR 3P		D706	8-719-976-99	ZENER DIODE DTZ5.1B	
CN520*	1-564-509-11	PLUG, CONNECTOR 6P		D707	8-719-911-19	DIODE 1SS119-25	
		<COMPOSITION CIRCUIT BLOCK>		D708	8-719-028-72	DIODE RGP02-17EL-6433	
CP701 Δ	1-453-271-11	RESISTER ASSY, HV (WF-722,HK)		D709	8-719-979-85	DIODE EGP20G	
		<DIODE>		D710	8-719-028-72	DIODE RGP02-17EL-6433	
D004	8-719-062-51	DIODE 1PS226-115		D711	8-719-976-99	ZENER DIODE DTZ5.1B	
				D921	8-719-404-49	DIODE MA111	
				D924	8-719-976-99	ZENER DIODE DTZ5.1B	
				D1001	8-719-404-49	DIODE MA111	
				D1002	8-719-404-49	DIODE MA111	
				D1003	8-719-404-49	DIODE MA111	
				D1004	8-719-404-49	DIODE MA111	



Les composants identifiés par un trame et une marque Δ sont critiques pour la sécurité. Ne les remplacer que par une pièce portant le numéro spécifié.

The components identified by shading and mark Δ are critical for safety. Replace only with part number specified.

REF.NO.	PART NO.	DESCRIPTION	REMARK	REF.NO.	PART NO.	DESCRIPTION	REMARK
D1005	8-719-404-49	DIODE MA111		L503	1-416-455-11	COIL, HORIZONTAL LINEARITY	
D1006	8-719-109-85	ZENER DIODE RD5.1ESB2		L504	1-416-836-11	COIL, HORIZONTAL LINEARITY	
D1007	8-719-801-78	DIODE 1SS184		L505	1-406-675-11	COIL, CHOKE 4.7mH	
D1501	8-719-976-99	ZENER DIODE DTZ5.1B		L507	1-406-675-11	COIL, CHOKE 4.7mH	
D1502	8-719-404-49	DIODE MA111		L701	1-412-537-31	INDUCTOR 100 μ H	
D1503	8-719-404-49	DIODE MA111		L702	1-412-522-41	INDUCTOR 5.6 μ H	
<FERRITE BEAD>				<IC LINK>			
FB001	1-410-397-21	FERRITE 1.1 μ H		PS501 Δ	1-533-592-31	LINK, IC (1.6A/90V AC, 60V DC)	
FB002	1-410-397-21	FERRITE 1.1 μ H		PS502 Δ	1-532-984-91	LINK, IC (2A/90V)	
FB003	1-410-397-21	FERRITE 1.1 μ H		PS503 Δ	1-532-984-91	LINK, IC (2A/90V)	
FB501	1-410-397-21	FERRITE 1.1 μ H		PS504 Δ	1-532-984-91	LINK, IC (2A/90V)	
FB502	1-410-397-21	FERRITE 1.1 μ H		PS701 Δ	1-533-590-31	LINK, IC (1A/90V AC, 60V DC)	
FB10251	1-414-232-11	INDUCTOR CHIP		<TRANSISTOR>			
<IC>				Q001	8-729-027-31	TRANSISTOR DTA124EKA-T146	
IC001	8-759-545-58	IC MB90F553APF-G-N01		Q003	8-729-216-22	TRANSISTOR 2SA1162-G	
IC002	8-759-442-20	IC 24LC21AT/SN		Q004	8-729-216-22	TRANSISTOR 2SA1162-G	
IC003	8-759-168-20	IC TA78L09S		Q005	8-729-216-22	TRANSISTOR 2SA1162-G	
IC004	8-759-527-77	IC M24C16-MN6T		Q006	8-729-120-28	TRANSISTOR 2SC1623-L5L6	
IC005	8-759-162-80	IC MM1170BFB		Q007	8-729-120-28	TRANSISTOR 2SC1623-L5L6	
IC006	8-759-470-65	IC PQ05RD1B		Q501	8-729-120-28	TRANSISTOR 2SC1623-L5L6	
IC007	8-752-078-46	IC CXA2043Q		Q502	8-729-120-28	TRANSISTOR 2SC1623-L5L6	
IC008	8-759-701-59	IC NJM78M09FA		Q503	8-729-901-97	TRANSISTOR 2SA1036K-Q	
IC010	8-752-083-83	IC CXA2044M-T6		Q504	8-729-120-28	TRANSISTOR 2SC1623-L5L6	
IC011	8-759-239-14	IC TA78L05S		Q505	8-729-901-97	TRANSISTOR 2SA1036K-Q	
IC013	8-759-233-66	IC TC74HCT04AF		Q506	8-729-820-73	TRANSISTOR 2SC3746	
IC014	8-759-011-64	IC MC74HC4052F		Q507	8-729-035-54	TRANSISTOR 2SJ449	
IC016	8-759-332-39	IC μ PC24M06HF		Q508	8-729-045-36	TRANSISTOR 2SC5047S-SONY-CA	
IC502	8-759-803-42	IC LA6500-FA		Q509	8-729-033-25	TRANSISTOR DTC114GKA	
IC505	8-759-100-96	IC μ PC4558G2		Q510	8-729-120-28	TRANSISTOR 2SC1623-L5L6	
IC701	8-759-822-38	IC LA6510		Q511	8-729-140-50	TRANSISTOR 2SC3209LK	
IC702	8-759-444-82	IC LA7841L		Q512	8-729-120-28	TRANSISTOR 2SC1623-L5L6	
IC703	8-759-100-96	IC μ PC4558G2		Q514	8-729-045-94	TRANSISTOR 2SK2518-01MR-F119	
IC1004	8-759-233-66	IC TC74HCT04AF		Q516	8-729-029-06	TRANSISTOR DTC124EUA-T106	
<CHIP CONDUCTOR>				Q517	8-729-216-22	TRANSISTOR 2SA1162-G	
JR001	1-216-295-91	SHORT 0		Q518	8-729-029-06	TRANSISTOR DTC124EUA-T106	
JR002	1-216-295-91	SHORT 0		Q519	8-729-029-06	TRANSISTOR DTC124EUA-T106	
JR501	1-216-295-91	SHORT 0		Q520	8-729-029-06	TRANSISTOR DTC124EUA-T106	
<COIL>				Q521	8-729-029-06	TRANSISTOR DTC124EUA-T106	
L001	1-406-665-11	COIL, CHOKE 100 μ H		Q522	8-729-045-94	TRANSISTOR 2SK2518-01MR-F119	
L002	1-406-665-11	COIL, CHOKE 100 μ H		Q523	8-729-045-94	TRANSISTOR 2SK2518-01MR-F119	
L003	1-412-537-31	INDUCTOR 100 μ H		Q524	8-729-045-94	TRANSISTOR 2SK2518-01MR-F119	
L004	1-412-537-31	INDUCTOR 100 μ H		Q525	8-729-045-94	TRANSISTOR 2SK2518-01MR-F119	
L005	1-412-537-31	INDUCTOR 100 μ H		Q526	8-729-045-94	TRANSISTOR 2SK2518-01MR-F119	
L006	1-410-482-31	INDUCTOR 100 μ H		Q527	8-729-045-94	TRANSISTOR 2SK2518-01MR-F119	
L007	1-412-537-31	INDUCTOR 100 μ H		Q528	8-729-045-94	TRANSISTOR 2SK2518-01MR-F119	
L008	1-412-537-31	INDUCTOR 100 μ H		Q529	8-729-029-06	TRANSISTOR DTC124EUA-T106	
L501	1-412-537-31	INDUCTOR 100 μ H		Q702	8-729-207-82	TRANSISTOR 2SC3421-Y	
L502	1-406-671-11	COIL, CHOKE 1.0mH		Q709	8-729-207-89	TRANSISTOR 2SA1358-Y	
				Q710	8-729-178-43	TRANSISTOR 2SC2784-E	
				Q711	8-729-204-91	TRANSISTOR 2SA1049-GR	
				Q712	8-729-800-32	TRANSISTOR 2SC2362K-G	
				Q713	8-729-020-07	TRANSISTOR 2SC4686A(LBSONY)	
				Q714	8-729-216-22	TRANSISTOR 2SA1162-G	



REF.NO.	PART NO.	DESCRIPTION	REMARK	REF.NO.	PART NO.	DESCRIPTION	REMARK
Q1001	8-729-120-28	TRANSISTOR 2SC1623-L5L6		R052	1-216-073-00	RES,CHIP 10K	5% 1/10W
Q1002	8-729-120-28	TRANSISTOR 2SC1623-L5L6		R053	1-216-675-11	METAL CHIP 10K	0.50%1/10W
Q1003	8-729-120-28	TRANSISTOR 2SC1623-L5L6		R054	1-216-675-11	METAL CHIP 10K	0.50%1/10W
Q1004	8-729-120-28	TRANSISTOR 2SC1623-L5L6		R055	1-216-089-91	RES,CHIP 47K	5% 1/10W
Q1006	8-729-028-83	TRANSISTOR DTA124EUA-T106		R056	1-216-671-11	METAL CHIP 6.8K	0.50%1/10W
				R057	1-216-679-11	METAL CHIP 15K	0.50%1/10W
Q1007	8-729-028-74	TRANSISTOR DTA114TUA-T106		R058	1-216-663-11	METAL CHIP 3.3K	0.50%1/10W
Q1008	8-729-028-83	TRANSISTOR DTA124EUA-T106		R059	1-216-065-91	RES,CHIP 4.7K	5% 1/10W
Q1009	8-729-029-06	TRANSISTOR DTC124EUA-T106		R060	1-216-025-91	RES,CHIP 100	5% 1/10W
				R061	1-216-065-91	RES,CHIP 4.7K	5% 1/10W
				R062	1-216-025-91	RES,CHIP 100	5% 1/10W
		<RESISTOR>		R063	1-216-025-91	RES,CHIP 100	5% 1/10W
R001	1-216-025-91	RES,CHIP 100	5% 1/10W	R064	1-216-025-91	RES,CHIP 100	5% 1/10W
R002	1-216-049-91	RES,CHIP 1K	5% 1/10W	R065	1-216-025-91	RES,CHIP 100	5% 1/10W
R003	1-216-049-91	RES,CHIP 1K	5% 1/10W	R066	1-216-025-91	RES,CHIP 100	5% 1/10W
R004	1-216-049-91	RES,CHIP 1K	5% 1/10W	R067	1-216-025-91	RES,CHIP 100	5% 1/10W
R005	1-216-073-00	RES,CHIP 10K	5% 1/10W	R068	1-216-025-91	RES,CHIP 100	5% 1/10W
R006	1-216-049-91	RES,CHIP 1K	5% 1/10W	R069	1-216-017-91	RES,CHIP 47	5% 1/10W
R007	1-216-025-91	RES,CHIP 100	5% 1/10W	R070	1-216-675-11	METAL CHIP 10K	0.50%1/10W
R008	1-216-089-91	RES,CHIP 47K	5% 1/10W	R071	1-216-049-91	RES,CHIP 1K	5% 1/10W
R009	1-216-025-91	RES,CHIP 100	5% 1/10W	R072	1-216-651-11	METAL CHIP 1K	0.50%1/10W
R010	1-216-081-00	RES,CHIP 22K	5% 1/10W	R073	1-216-295-91	SHORT 0	
R011	1-216-097-91	RES,CHIP 100K	5% 1/10W	R074	1-216-675-11	METAL CHIP 10K	0.50%1/10W
R012	1-216-025-91	RES,CHIP 100	5% 1/10W	R075	1-216-049-91	RES,CHIP 1K	5% 1/10W
R013	1-216-675-11	METAL CHIP 10K	0.50%1/10W	R076	1-216-049-91	RES,CHIP 1K	5% 1/10W
R014	1-216-049-91	RES,CHIP 1K	5% 1/10W	R077	1-216-049-91	RES,CHIP 1K	5% 1/10W
R015	1-216-049-91	RES,CHIP 1K	5% 1/10W	R078	1-216-049-91	RES,CHIP 1K	5% 1/10W
R017	1-216-073-00	RES,CHIP 10K	5% 1/10W	R081	1-216-675-11	METAL CHIP 10K	0.50%1/10W
R018	1-216-049-91	RES,CHIP 1K	5% 1/10W	R082	1-216-049-91	RES,CHIP 1K	5% 1/10W
R020	1-216-049-91	RES,CHIP 1K	5% 1/10W	R083	1-216-057-00	RES,CHIP 2.2K	5% 1/10W
R023	1-216-025-91	RES,CHIP 100	5% 1/10W	R084	1-216-073-00	RES,CHIP 10K	5% 1/10W
R024	1-216-089-91	RES,CHIP 47K	5% 1/10W	R085	1-216-025-91	RES,CHIP 100	5% 1/10W
R025	1-216-295-91	SHORT 0		R086	1-216-049-91	RES,CHIP 1K	5% 1/10W
R026	1-216-073-00	RES,CHIP 10K	5% 1/10W	R087	1-216-049-91	RES,CHIP 1K	5% 1/10W
R027	1-216-073-00	RES,CHIP 10K	5% 1/10W	R088	1-216-057-00	RES,CHIP 2.2K	5% 1/10W
R030	1-216-017-91	RES,CHIP 47	5% 1/10W	R089	1-216-057-00	RES,CHIP 2.2K	5% 1/10W
R031	1-216-073-00	RES,CHIP 10K	5% 1/10W	R090	1-216-057-00	RES,CHIP 2.2K	5% 1/10W
R032	1-216-675-11	METAL CHIP 10K	0.50%1/10W	R092	1-216-057-00	RES,CHIP 2.2K	5% 1/10W
R033	1-216-017-91	RES,CHIP 47	5% 1/10W	R094	1-216-057-00	RES,CHIP 2.2K	5% 1/10W
R034	1-216-025-91	RES,CHIP 100	5% 1/10W	R096	1-216-295-91	SHORT 0	
R035	1-216-049-91	RES,CHIP 1K	5% 1/10W	R097	1-216-057-00	RES,CHIP 2.2K	5% 1/10W
R036	1-216-025-91	RES,CHIP 100	5% 1/10W	R101	1-216-049-91	RES,CHIP 1K	5% 1/10W
R037	1-216-686-11	METAL CHIP 30K	0.50%1/10W	R501	1-216-065-91	RES,CHIP 4.7K	5% 1/10W
R038	1-216-685-11	METAL CHIP 27K	0.50%1/10W	R502	1-216-057-00	RES,CHIP 2.2K	5% 1/10W
R039	1-216-049-91	RES,CHIP 1K	5% 1/10W	R503	1-216-041-00	RES,CHIP 470	5% 1/10W
R040	1-216-049-91	RES,CHIP 1K	5% 1/10W	R504	1-216-057-00	RES,CHIP 2.2K	5% 1/10W
R041	1-216-065-91	RES,CHIP 4.7K	5% 1/10W	R505	1-216-041-00	RES,CHIP 470	5% 1/10W
R042	1-216-089-91	RES,CHIP 47K	5% 1/10W	R506	1-249-397-11	CARBON 22	5% 1/4W F
R043	1-216-065-91	RES,CHIP 4.7K	5% 1/10W	R507	1-216-065-91	RES,CHIP 4.7K	5% 1/10W
R044	1-216-095-00	RES,CHIP 82K	5% 1/10W	R508	1-216-025-91	RES,CHIP 100	5% 1/10W
R045	1-216-073-00	RES,CHIP 10K	5% 1/10W	R509	1-216-057-00	RES,CHIP 2.2K	5% 1/10W
R046	1-216-675-11	METAL CHIP 10K	0.50%1/10W	R510	1-216-065-91	RES,CHIP 4.7K	5% 1/10W
R047	1-216-073-00	RES,CHIP 10K	5% 1/10W	R511	1-219-731-11	METAL 2.4	1% 10W
R048	1-216-049-91	RES,CHIP 1K	5% 1/10W	R512	1-216-627-11	METAL CHIP 100	0.50%1/10W
R050	1-216-025-91	RES,CHIP 100	5% 1/10W	R513	1-215-860-11	METAL OXIDE 33	5% 1W F
R051	1-216-679-11	METAL CHIP 15K	0.50%1/10W	R514	1-211-796-11	FUSIBLE 1	5% 1/2W F

GDM-F500/F500T9



REF.NO.	PART NO.	DESCRIPTION	REMARK	REF.NO.	PART NO.	DESCRIPTION	REMARK
R515	1-216-675-11	METAL CHIP	10K	0.50%	1/10W		
R516	1-247-815-91	CARBON	220	5%	1/4W		
R517	1-216-065-91	RES,CHIP	4.7K	5%	1/10W		
R518	1-216-097-91	RES,CHIP	100K	5%	1/10W		
R519	1-216-393-00	METAL OXIDE	2.2	5%	3W	F	
R520	1-216-393-00	METAL OXIDE	2.2	5%	3W	F	
R521	1-260-324-11	CARBON	470	5%	1/2W		
R522	1-216-423-11	METAL OXIDE	27	5%	1W	F	
R523	1-249-421-11	CARBON	2.2K	5%	1/4W	F	
R524	1-215-869-11	METAL OXIDE	1K	5%	1W	F	
R525	1-216-681-11	METAL CHIP	18K	0.50%	1/10W		
R526	1-214-840-00	METAL	100	1%	1/2W		
R527	1-214-840-00	METAL	100	1%	1/2W		
R528	1-214-840-00	METAL	100	1%	1/2W		
R529	1-260-313-51	CARBON	56	5%	1/2W		
R530	1-249-437-11	CARBON	47K	5%	1/4W		
R531	1-249-437-11	CARBON	47K	5%	1/4W		
R532	1-249-437-11	CARBON	47K	5%	1/4W		
R533	1-249-437-11	CARBON	47K	5%	1/4W		
R534	1-249-437-11	CARBON	47K	5%	1/4W		
R535	1-216-049-91	RES,CHIP	1K	5%	1/10W		
R536	1-216-049-91	RES,CHIP	1K	5%	1/10W		
R537	1-216-049-91	RES,CHIP	1K	5%	1/10W		
R538	1-216-049-91	RES,CHIP	1K	5%	1/10W		
R539	1-216-049-91	RES,CHIP	1K	5%	1/10W		
R540	1-216-073-00	RES,CHIP	10K	5%	1/10W		
R541	1-260-314-11	CARBON	68	5%	1/2W		
R542	1-215-863-11	METAL OXIDE	100	5%	1W	F	
R543	1-216-647-11	METAL CHIP	680	0.50%	1/10W		
R544	1-260-085-11	CARBON	68	5%	1/2W		
R545	1-216-683-11	METAL CHIP	22K	0.50%	1/10W		
R546	1-260-288-11	CARBON	0.47	5%	1/2W		
R547	1-216-663-11	METAL CHIP	3.3K	0.50%	1/10W		
R548	1-215-443-00	METAL	8.2K	1%	1/4W		
R549	1-216-675-11	METAL CHIP	10K	0.50%	1/10W		
R550	1-260-288-11	CARBON	0.47	5%	1/2W		
R551	1-216-659-11	METAL CHIP	2.2K	0.50%	1/10W		
R552	1-216-057-00	RES,CHIP	2.2K	5%	1/10W		
R553	1-216-655-11	METAL CHIP	1.5K	0.50%	1/10W		
R554	1-216-675-11	METAL CHIP	10K	0.50%	1/10W		
R555	1-216-065-91	RES,CHIP	4.7K	5%	1/10W		
R556	1-216-674-11	METAL CHIP	9.1K	0.50%	1/10W		
R558	1-216-683-11	METAL CHIP	22K	0.50%	1/10W		
R561	1-216-683-11	METAL CHIP	22K	0.50%	1/10W		
R562	1-249-401-11	CARBON	47	5%	1/4W	F	
R563	1-216-662-11	METAL CHIP	3K	0.50%	1/10W		
R564	1-216-697-91	METAL CHIP	82K	0.50%	1/10W		
R565	1-216-671-11	METAL CHIP	6.8K	0.50%	1/10W		
R566	1-216-424-11	METAL OXIDE	39	5%	1W	F	
R567	1-216-627-11	METAL CHIP	100	0.50%	1/10W		
R568	1-216-655-11	METAL CHIP	1.5K	0.50%	1/10W		
R569	1-249-437-11	CARBON	47K	5%	1/4W		
R570	1-216-097-91	RES,CHIP	100K	5%	1/10W		
R571	1-216-381-11	METAL OXIDE	0.22	5%	3W	F	
R572	1-216-097-91	RES,CHIP	100K	5%	1/10W		
R573	1-216-097-91	RES,CHIP	100K	5%	1/10W		
R574	1-216-097-91	RES,CHIP	100K	5%	1/10W		
R575	1-216-097-91	RES,CHIP	100K	5%	1/10W		
R576	1-216-097-91	RES,CHIP	100K	5%	1/10W		
R577	1-216-057-00	RES,CHIP	2.2K	5%	1/10W		
R579	1-216-672-11	METAL CHIP	7.5K	0.50%	1/10W		
R580	1-216-073-00	RES,CHIP	10K	5%	1/10W		
R581	1-216-073-00	RES,CHIP	10K	5%	1/10W		
R582	1-216-073-00	RES,CHIP	10K	5%	1/10W		
R583	1-216-675-11	METAL CHIP	10K	0.50%	1/10W		
R584	1-216-081-00	RES,CHIP	22K	5%	1/10W		
R585	1-216-081-00	RES,CHIP	22K	5%	1/10W		
R586	1-216-049-91	RES,CHIP	1K	5%	1/10W		
R587	1-216-049-91	RES,CHIP	1K	5%	1/10W		
R588	1-216-097-91	RES,CHIP	100K	5%	1/10W		
R589	1-216-097-91	RES,CHIP	100K	5%	1/10W		
R590	1-216-675-11	METAL CHIP	10K	0.50%	1/10W		
R591	1-216-675-11	METAL CHIP	10K	0.50%	1/10W		
R592	1-216-049-91	RES,CHIP	1K	5%	1/10W		
R594	1-249-437-11	CARBON	47K	5%	1/4W		
R595	1-249-437-11	CARBON	47K	5%	1/4W		
R596	1-216-683-11	METAL CHIP	22K	0.50%	1/10W		
R701	1-249-383-11	CARBON	1.5	5%	1/4W	F	
R702	1-216-057-00	RES,CHIP	2.2K	5%	1/10W		
R703	1-216-085-00	RES,CHIP	33K	5%	1/10W		
R704	1-249-383-11	CARBON	1.5	5%	1/4W	F	
R705	1-249-385-11	CARBON	2.2	5%	1/4W		
R706	1-216-093-00	RES,CHIP	68K	5%	1/10W		
R707	1-249-421-11	CARBON	2.2K	5%	1/4W		
R708	1-216-073-00	RES,CHIP	10K	5%	1/10W		
R709	1-216-473-11	METAL OXIDE	56	5%	3W	F	
R710	1-216-073-00	RES,CHIP	10K	5%	1/10W		
R711	1-219-746-11	CARBON	1K	5%	1/2W		
R712	1-215-881-11	METAL OXIDE	15	5%	2W	F	
R713	1-249-377-11	CARBON	0.47	5%	1/4W	F	
R714	1-249-377-11	CARBON	0.47	5%	1/4W	F	
R715	1-216-077-00	RES,CHIP	15K	5%	1/10W		
R716	1-249-413-11	CARBON	470	5%	1/4W	F	
R717	1-249-430-11	CARBON	12K	5%	1/4W		
R718	1-249-419-11	CARBON	1.5K	5%	1/4W		
R719	1-249-383-11	CARBON	1.5	5%	1/4W	F	
R720	1-260-292-11	CARBON	1	5%	1/2W		
R721	1-216-667-11	METAL CHIP	4.7K	0.50%	1/10W		
R722	1-216-691-11	METAL CHIP	47K	0.50%	1/10W		
R723	1-216-663-11	METAL CHIP	3.3K	0.50%	1/10W		
R724	1-214-798-21	METAL	1.8	1%	1/2W		
R725	1-214-798-21	METAL	1.8	1%	1/2W		
R726	1-216-675-11	METAL CHIP	10K	0.50%	1/10W		
R727	1-260-292-11	CARBON	1	5%	1/2W		
R728	1-249-381-11	CARBON	1	5%	1/4W	F	
R729	1-215-865-11	METAL OXIDE	220	5%	1W	F	
R731	1-216-073-00	RES,CHIP	10K	5%	1/10W		
R732	1-216-073-00	RES,CHIP	10K	5%	1/10W		
R735	1-216-049-91	RES,CHIP	1K	5%	1/10W		
R736	1-219-746-11	CARBON	1K	5%	1/2W		
R740	1-219-754-11	CARBON	680K	5%	1/2W		



REF.NO.	PART NO.	DESCRIPTION	REMARK	REF.NO.	PART NO.	DESCRIPTION	REMARK
R744	1-219-754-11	CARBON	680K	5%	1/2W		
R745	1-220-824-11	CARBON	270K	5%	1/2W		
R746	1-219-720-11	METAL	10M	5%	1W		
R747	1-216-083-00	RES,CHIP	27K	5%	1/10W		
R757	1-216-065-91	RES,CHIP	4.7K	5%	1/10W		
R758	1-216-057-00	RES,CHIP	2.2K	5%	1/10W		
R760	1-216-683-11	METAL CHIP	22K	0.50%	1/10W		
R761	1-216-049-91	RES,CHIP	1K	5%	1/10W		
R762	1-216-075-00	RES,CHIP	12K	5%	1/10W		
R763	1-218-754-11	METAL CHIP	120K	0.50%	1/10W		
R776	1-216-049-91	RES,CHIP	1K	5%	1/10W		
R777	1-216-681-11	METAL CHIP	18K	0.50%	1/10W		
R778	1-216-667-11	METAL CHIP	4.7K	0.50%	1/10W		
R779	1-216-049-91	RES,CHIP	1K	5%	1/10W		
R928	1-216-667-11	METAL CHIP	4.7K	0.50%	1/10W		
R941	1-216-025-91	RES,CHIP	100	5%	1/10W		
R1001	1-216-073-00	RES,CHIP	10K	5%	1/10W		
R1002	1-216-105-91	RES,CHIP	220K	5%	1/10W		
R1003	1-216-049-91	RES,CHIP	1K	5%	1/10W		
R1004	1-216-049-91	RES,CHIP	1K	5%	1/10W		
R1005	1-216-049-91	RES,CHIP	1K	5%	1/10W		
R1006	1-216-049-91	RES,CHIP	1K	5%	1/10W		
R1007	1-216-049-91	RES,CHIP	1K	5%	1/10W		
R1008	1-216-121-91	RES,CHIP	1M	5%	1/10W		
R1009	1-216-097-91	RES,CHIP	100K	5%	1/10W		
R1011	1-216-073-00	RES,CHIP	10K	5%	1/10W		
R1012	1-216-049-91	RES,CHIP	1K	5%	1/10W		
R1013	1-216-049-91	RES,CHIP	1K	5%	1/10W		
R1014	1-216-049-91	RES,CHIP	1K	5%	1/10W		
R1015	1-216-295-91	SHORT	0				
R1016	1-216-049-91	RES,CHIP	1K	5%	1/10W		
R1017	1-216-065-91	RES,CHIP	4.7K	5%	1/10W		
R1020	1-216-049-91	RES,CHIP	1K	5%	1/10W		
R1021	1-216-049-91	RES,CHIP	1K	5%	1/10W		
R1022	1-216-295-91	SHORT	0				
R1023	1-216-295-91	SHORT	0				
R1024	1-216-295-91	SHORT	0				
R1025	1-249-389-11	CARBON	4.7	5%	1/4W F		
R1027	1-216-065-91	RES,CHIP	4.7K	5%	1/10W		
R1028	1-216-089-91	RES,CHIP	47K	5%	1/10W		
R1031	1-216-121-91	RES,CHIP	1M	5%	1/10W		
R1032	1-216-073-00	RES,CHIP	10K	5%	1/10W		
R1033	1-216-097-91	RES,CHIP	100K	5%	1/10W		
R1036	1-216-049-91	RES,CHIP	1K	5%	1/10W		
R1037	1-216-105-91	RES,CHIP	220K	5%	1/10W		
R1038	1-216-049-91	RES,CHIP	1K	5%	1/10W		
R1039	1-216-073-00	RES,CHIP	10K	5%	1/10W		
R1040	1-216-097-91	RES,CHIP	100K	5%	1/10W		
R1043	1-216-049-91	RES,CHIP	1K	5%	1/10W		
R1044	1-216-105-91	RES,CHIP	220K	5%	1/10W		
R1045	1-216-049-91	RES,CHIP	1K	5%	1/10W		
R1049	1-216-055-00	RES,CHIP	1.8K	5%	1/10W		
R1052	1-216-073-00	RES,CHIP	10K	5%	1/10W		
R1053	1-216-073-00	RES,CHIP	10K	5%	1/10W		
R1054	1-216-073-00	RES,CHIP	10K	5%	1/10W		
R1055	1-216-041-00	RES,CHIP	470	5%	1/10W		
R1056	1-216-073-00	RES,CHIP	10K	5%	1/10W		
R1058	1-216-025-91	RES,CHIP	100	5%	1/10W		
R1059	1-216-025-91	RES,CHIP	100	5%	1/10W		
R1060	1-216-025-91	RES,CHIP	100	5%	1/10W		
R1061	1-216-049-91	RES,CHIP	1K	5%	1/10W		
R1062	1-216-025-91	RES,CHIP	100	5%	1/10W		
R1063	1-216-025-91	RES,CHIP	100	5%	1/10W		
R1064	1-216-025-91	RES,CHIP	100	5%	1/10W		
R1065	1-216-025-91	RES,CHIP	100	5%	1/10W		
R1066	1-216-025-91	RES,CHIP	100	5%	1/10W		
R1067	1-216-049-91	RES,CHIP	1K	5%	1/10W		
R1068	1-216-689-11	METAL CHIP	39K	0.50%	1/10W		
R1069	1-216-681-11	METAL CHIP	18K	0.50%	1/10W		
R1070	1-216-025-91	RES,CHIP	100	5%	1/10W		
R1071	1-216-025-91	RES,CHIP	100	5%	1/10W		
R1072	1-216-025-91	RES,CHIP	100	5%	1/10W		
R1073	1-216-025-91	RES,CHIP	100	5%	1/10W		
R1074	1-216-025-91	RES,CHIP	100	5%	1/10W		
R1075	1-216-025-91	RES,CHIP	100	5%	1/10W		
R1077	1-216-081-00	RES,CHIP	22K	5%	1/10W		
R1078	1-216-049-91	RES,CHIP	1K	5%	1/10W		
R1079	1-216-049-91	RES,CHIP	1K	5%	1/10W		
R1080	1-216-057-00	RES,CHIP	2.2K	5%	1/10W		
R1081	1-216-057-00	RES,CHIP	2.2K	5%	1/10W		
R1501	1-216-057-00	RES,CHIP	2.2K	5%	1/10W		
R1502	1-216-073-00	RES,CHIP	10K	5%	1/10W		
R1503	1-216-129-00	RES,CHIP	2.2M	5%	1/10W		
R1504	1-216-097-91	RES,CHIP	100K	5%	1/10W		
R1505	1-216-065-91	RES,CHIP	4.7K	5%	1/10W		
R1506	1-216-065-91	RES,CHIP	4.7K	5%	1/10W		
R1507	1-216-065-91	RES,CHIP	4.7K	5%	1/10W		
R1508	1-216-065-91	RES,CHIP	4.7K	5%	1/10W		
R1509	1-216-065-91	RES,CHIP	4.7K	5%	1/10W		
R1510	1-216-065-91	RES,CHIP	4.7K	5%	1/10W		
R1513	1-216-049-91	RES,CHIP	1K	5%	1/10W		
R1514	1-216-049-91	RES,CHIP	1K	5%	1/10W		
						<RELAY>	
						RY501 1-755-137-11 RELAY	
						<SWITCH>	
						S001 1-572-922-11 SWITCH, SLIDE (OP/ST)	
						<SPARK GAP>	
						SG703 1-519-422-11 GAP, SPARK	
						SG704 1-519-422-11 GAP, SPARK	
						<TRANSFORMER>	
						T501 1-429-303-21 TRANSFORMER, FERRITE (HDT)	
						T502 1-416-401-11 COIL, CHOKE 5.0mH	
						T503 1-431-413-11 TRANSFORMER, FERRITE (HST)	
						T504 1-416-257-11 COIL, CHOKE 2.0mH	

GDM-F500/F500T9



REF.NO.	PART NO.	DESCRIPTION	REMARK	REF.NO.	PART NO.	DESCRIPTION	REMARK
T702	1-431-414-11	TRANSFORMER, FERRITE (DFT)		R827	1-249-407-11	CARBON 150	5% 1/4W
		<THERMISTOR>		R828	1-215-421-00	METAL 1K	1% 1/4W
TH501	1-807-796-11	THERMISTOR				<SWITCH>	
TH502	1-807-796-11	THERMISTOR		S801	1-771-464-11	SWITCH, STICK (CONT +/-, BRT +/-)	
		<CRYSTAL>				<THERMISTOR>	
X001	1-567-781-61	VIBRATOR, CRYSTAL (4MHZ)		TH801	1-807-796-11	THERMISTOR	
*****				*****			
	* 8-933-324-00 H1 BOARD, COMPLETE (included H2) *****				* 8-933-324-00 H2 BOARD, COMPLETE (included H1) *****		
		<CAPACITOR>				<DIODE>	
C805	1-124-589-11	ELECT 47μF	20% 16V	D812	8-719-060-26	DIODE SLR-325YCT31	
C806	1-124-589-11	ELECT 47μF	20% 16V	D813	8-719-060-26	DIODE SLR-325YCT31	
C811	1-124-589-11	ELECT 47μF	20% 16V			<TRANSISTOR>	
		<CONNECTOR>		Q803	8-729-119-78	TRANSISTOR 2SC2785-HFE	
CN801	1-784-970-11	PIN, CONNECTOR (PC BOARD) 12P		Q804	8-729-119-78	TRANSISTOR 2SC2785-HFE	
		<DIODE>				<RESISTOR>	
D810	8-719-064-11	DIODE SPR-325MVW		R807	1-215-433-00	METAL 3.3K	1% 1/4W
		<TRANSISTOR>		R808	1-215-409-00	METAL 330	1% 1/4W
Q801	8-729-119-78	TRANSISTOR 2SC2785-HFE		R809	1-215-409-00	METAL 330	1% 1/4W
Q802	8-729-119-78	TRANSISTOR 2SC2785-HFE		R810	1-215-413-00	METAL 470	1% 1/4W
Q805	8-729-119-78	TRANSISTOR 2SC2785-HFE		R812	1-247-815-91	CARBON 220	5% 1/4W
Q806	8-729-119-78	TRANSISTOR 2SC2785-HFE		R813	1-247-815-91	CARBON 220	5% 1/4W
		<RESISTOR>		R816	1-247-863-91	CARBON 22K	5% 1/4W
R801	1-215-429-00	METAL 2.2K	1% 1/4W	R817	1-247-863-91	CARBON 22K	5% 1/4W
R802	1-215-437-00	METAL 4.7K	1% 1/4W	R824	1-247-863-91	CARBON 22K	5% 1/4W
R803	1-215-433-00	METAL 3.3K	1% 1/4W	R825	1-247-863-91	CARBON 22K	5% 1/4W
R804	1-215-421-00	METAL 1K	1% 1/4W			<SWITCH>	
R805	1-215-417-00	METAL 680	1% 1/4W	S807	1-554-303-21	SWITCH, KEY BOARD(INPUT)	
R806	1-215-413-00	METAL 470	1% 1/4W	S808	1-554-303-21	SWITCH, KEY BOARD(ASC)	
R814	1-249-429-11	CARBON 10K	5% 1/4W	S809	1-554-303-21	SWITCH, KEY BOARD(RESET)	
R815	1-249-429-11	CARBON 10K	5% 1/4W			*****	
R818	1-215-445-00	METAL 10K	1% 1/4W			* 8-933-322-00 J BOARD, COMPLETE *****	
R819	1-249-441-11	CARBON 100K	5% 1/4W			<CONNECTOR>	
R820	1-249-429-11	CARBON 10K	5% 1/4W	CN891	1-691-960-11	PIN, CONNECTOR (PC BOARD) 3P	
R821	1-247-807-31	CARBON 100	5% 1/4W				
R822	1-249-419-11	CARBON 1.5K	5% 1/4W				
R823	1-249-415-11	CARBON 680	5% 1/4W				
R826	1-249-413-11	CARBON 470	5% 1/4W				

The components identified by shading and mark Δ are critical for safety. Replace only with part number specified.

Les composants identifiés par un trame et une marque Δ sont critiques pour la sécurité. Ne les remplacer que par une pièce portant le numéro spécifié.



REF.NO.	PART NO.	DESCRIPTION	REMARK	REF.NO.	PART NO.	DESCRIPTION	REMARK
		<SWITCH>				<CONNECTOR>	
	S891 Δ	1-571-433-31 SWITCH, PUSH (AC POWER)			CN5001*	1-564-512-11 PLUG, CONNECTOR 9P	
					CN5002*	1-564-509-11 PLUG, CONNECTOR 6P	
					CN5003	1-564-513-11 PLUG, CONNECTOR 10P	
					CN5004*	1-564-507-11 PLUG, CONNECTOR 4P	

		* 8-933-325-00 L BOARD, COMPLETE				<DIODE>	
					D5002	8-719-801-78 DIODE 1SS184	
					D5101	8-719-062-51 DIODE 1PS226-115	
					D5103	8-719-062-51 DIODE 1PS226-115	
					D5201	8-719-062-51 DIODE 1PS226-115	
					D5301	8-719-062-51 DIODE 1PS226-115	
					D5303	8-719-062-51 DIODE 1PS226-115	
					D5401	8-719-062-51 DIODE 1PS226-115	
					D5403	8-719-062-51 DIODE 1PS226-115	
					D5501	8-719-976-96 ZENER DIODE DTZ4.7C	
						<SENSOR>	
					GS50011	475-592-11 SENSOR UNIT, MAGNETIC	
						<IC>	
					IC5101	8-759-822-38 IC LA6510	
					IC5201	8-759-803-42 IC LA6500-FA	
					IC5301	8-759-822-38 IC LA6510	
					IC5401	8-759-822-38 IC LA6510	
						<RESISTOR>	
					R5001	1-249-383-11 CARBON 1.5 5% 1/4W F	
					R5003	1-216-295-91 SHORT 0	
					R5005	1-216-689-11 RES,CHIP 39K 5% 1/10W	
					R5006	1-216-073-00 RES,CHIP 10K 5% 1/10W	
					R5007	1-216-049-91 RES,CHIP 1K 5% 1/10W	
					R5010	1-216-295-91 SHORT 0	
					R5011	1-216-073-00 RES,CHIP 10K 5% 1/10W	
					R5015	1-216-049-91 RES,CHIP 1K 5% 1/10W	
					R5101	1-249-383-11 CARBON 1.5 5% 1/4W F	
					R5102	1-249-383-11 CARBON 1.5 5% 1/4W F	
					R5108	1-216-308-00 RES,CHIP 4.7 5% 1/10W	
					R5109	1-216-308-00 RES,CHIP 4.7 5% 1/10W	
					R5110	1-216-073-00 RES,CHIP 10K 5% 1/10W	
					R5111	1-216-308-00 RES,CHIP 4.7 5% 1/10W	
					R5112	1-249-383-11 CARBON 1.5 5% 1/4W F	
					R5113	1-216-073-00 RES,CHIP 10K 5% 1/10W	
					R5114	1-249-441-11 CARBON 100K 5% 1/4W F	
					R5115	1-215-882-00 METAL OXIDE 22 5% 2W F	
					R5116	1-216-073-00 RES,CHIP 10K 5% 1/10W	
					R5117	1-216-308-00 RES,CHIP 4.7 5% 1/10W	
					R5119	1-216-073-00 RES,CHIP 10K 5% 1/10W	
					R5120	1-249-383-11 CARBON 1.5 5% 1/4W F	
					R5121	1-249-441-11 CARBON 100K 5% 1/4W F	
					R5122	1-215-882-00 METAL OXIDE 22 5% 2W F	
					R5201	1-249-383-11 CARBON 1.5 5% 1/4W F	
		<CAPACITOR>					
	C5002	1-126-964-11 ELECT 10 μ F	20% 50V				
	C5003	1-126-933-11 ELECT 100 μ F	20% 16V				
	C5004	1-104-664-11 ELECT 47 μ F	20% 25V				
	C5005	1-104-664-11 ELECT 47 μ F	20% 25V				
	C5008	1-104-664-11 ELECT 47 μ F	20% 25V				
	C5009	1-164-004-11 CERAMIC CHIP 0.1 μ F	10% 25V				
	C5101	1-164-004-11 CERAMIC CHIP 0.1 μ F	10% 25V				
	C5103	1-164-004-11 CERAMIC CHIP 0.1 μ F	10% 25V				
	C5104	1-164-004-11 CERAMIC CHIP 0.1 μ F	10% 25V				
	C5105	1-104-664-11 ELECT 47 μ F	20% 25V				
	C5106	1-164-004-11 CERAMIC CHIP 0.1 μ F	10% 25V				
	C5107	1-130-495-00 FILM 0.1 μ F	5% 50V				
	C5108	1-164-004-11 CERAMIC CHIP 0.1 μ F	10% 25V				
	C5109	1-164-004-11 CERAMIC CHIP 0.1 μ F	10% 25V				
	C5110	1-104-664-11 ELECT 47 μ F	20% 25V				
	C5111	1-130-495-00 FILM 0.1 μ F	5% 50V				
	C5201	1-104-664-11 ELECT 47 μ F	20% 25V				
	C5202	1-104-664-11 ELECT 47 μ F	20% 25V				
	C5203	1-164-004-11 CERAMIC CHIP 0.1 μ F	10% 25V				
	C5204	1-130-495-00 FILM 0.1 μ F	5% 50V				
	C5205	1-164-489-11 CERAMIC CHIP 0.22 μ F	10% 16V				
	C5206	1-164-004-11 CERAMIC CHIP 0.1 μ F	10% 25V				
	C5301	1-164-004-11 CERAMIC CHIP 0.1 μ F	10% 25V				
	C5303	1-164-004-11 CERAMIC CHIP 0.1 μ F	10% 25V				
	C5304	1-164-004-11 CERAMIC CHIP 0.1 μ F	10% 25V				
	C5305	1-104-664-11 ELECT 47 μ F	20% 25V				
	C5306	1-164-004-11 CERAMIC CHIP 0.1 μ F	10% 25V				
	C5307	1-130-495-00 FILM 0.1 μ F	5% 50V				
	C5308	1-164-004-11 CERAMIC CHIP 0.1 μ F	10% 25V				
	C5309	1-164-004-11 CERAMIC CHIP 0.1 μ F	10% 25V				
	C5310	1-104-664-11 ELECT 47 μ F	20% 25V				
	C5311	1-130-495-00 FILM 0.1 μ F	5% 50V				
	C5401	1-164-004-11 CERAMIC CHIP 0.1 μ F	10% 25V				
	C5403	1-163-021-91 CERAMIC CHIP 0.01 μ F	10% 50V				
	C5404	1-164-004-11 CERAMIC CHIP 0.1 μ F	10% 25V				
	C5405	1-104-664-11 ELECT 47 μ F	20% 25V				
	C5406	1-164-004-11 CERAMIC CHIP 0.1 μ F	10% 25V				
	C5407	1-130-495-00 FILM 0.1 μ F	5% 50V				
	C5408	1-163-003-11 CERAMIC CHIP 330pF	10% 50V				
	C5409	1-164-004-11 CERAMIC CHIP 0.1 μ F	10% 25V				
	C5410	1-104-664-11 ELECT 47 μ F	20% 25V				
	C5412	1-164-004-11 CERAMIC CHIP 0.1 μ F	10% 25V				
	C5501	1-126-934-11 ELECT 220 μ F	20% 10V				

GDM-F500/F500T9



REF.NO.	PART NO.	DESCRIPTION	REMARK	REF.NO.	PART NO.	DESCRIPTION	REMARK
R5202	1-249-383-11	CARBON 1.5	5% 1/4W F	* 8-933-321-00	US BOARD, COMPLETE	(OLD)	
R5203	1-249-383-11	CARBON 1.5	5% 1/4W F	*****			
R5204	1-249-441-11	CARBON 100K	5% 1/4W F				
R5205	1-216-073-00	RES,CHIP 10K	5% 1/10W			F500(U/C) : S/N 2,700,001 to 2,701,030	
R5206	1-215-859-00	METAL OXIDE 22	5% 1W F			F500(AEP) : S/N 2,800,001 to 2,801,280	
R5207	1-216-073-00	RES,CHIP 10K	5% 1/10W				
R5208	1-216-670-11	METAL CHIP 6.2K	0.50% 1/10W	* 8-933-321-00	US BOARD, COMPLETE	(NEW)	
R5301	1-249-383-11	CARBON 1.5	5% 1/4W F	*****			
R5302	1-249-383-11	CARBON 1.5	5% 1/4W F			F500(U/C) : S/N 2,701,031 and later	
R5308	1-216-308-00	RES,CHIP 4.7	5% 1/10W			F500(AEP) : S/N 2,801,281 and later	
R5309	1-216-308-00	RES,CHIP 4.7	5% 1/10W			F500T9 : All units	
R5310	1-216-073-00	RES,CHIP 10K	5% 1/10W			Note: Old model and new model of US complete board have	
R5311	1-216-308-00	RES,CHIP 4.7	5% 1/10W			interchangeability, and only new model of US complete	
R5312	1-249-383-11	CARBON 1.5	5% 1/4W F			board is supplied.	
R5313	1-216-073-00	RES,CHIP 10K	5% 1/10W				
R5314	1-249-441-11	CARBON 100K	5% 1/4W F			<CAPACITOR>	
R5315	1-215-882-00	METAL OXIDE 22	5% 2W F	C2601	1-163-021-91	CERAMIC CHIP 0.01uF	10% 50V
R5316	1-216-073-00	RES,CHIP 10K	5% 1/10W	C2602	1-104-664-11	ELECT 47uF	20% 25V
R5317	1-216-308-00	RES,CHIP 4.7	5% 1/10W				(NEW)
R5319	1-216-073-00	RES,CHIP 10K	5% 1/10W	C2602	1-164-004-11	CERAMIC CHIP 0.1uF	10% 25V
R5320	1-249-383-11	CARBON 1.5	5% 1/4W F				(OLD)
R5321	1-249-441-11	CARBON 100K	5% 1/4W F	C2603	1-104-664-11	ELECT 47uF	20% 25V
R5322	1-215-882-00	METAL OXIDE 22	5% 2W F				(NEW)
R5401	1-249-383-11	CARBON 1.5	5% 1/4W F	C2603	1-164-004-11	CERAMIC CHIP 0.1uF	10% 25V
R5402	1-249-383-11	CARBON 1.5	5% 1/4W F				(OLD)
R5406	1-216-689-11	RES,CHIP 39K	5% 1/10W	C2605	1-104-664-11	ELECT 47uF	20% 25V
R5407	1-216-079-00	RES,CHIP 18K	5% 1/10W				(NEW)
R5408	1-216-308-00	RES,CHIP 4.7	5% 1/10W	C2606	1-104-664-11	ELECT 47uF	20% 25V
R5409	1-216-308-00	RES,CHIP 4.7	5% 1/10W				(NEW)
R5410	1-216-049-91	RES,CHIP 1K	5% 1/10W	C2607	1-126-934-11	ELECT 220uF	20% 10V
R5411	1-216-308-00	RES,CHIP 4.7	5% 1/10W				(NEW)
R5412	1-249-383-11	CARBON 1.5	5% 1/4W F	C2608	1-104-664-11	ELECT 47uF	20% 25V
R5413	1-216-097-91	RES,CHIP 100K	5% 1/10W				(OLD)
R5414	1-249-441-11	CARBON 100K	5% 1/4W F	C2608	1-126-934-11	ELECT 220uF	20% 10V
R5415	1-215-886-11	METAL OXIDE 100	5% 2W F				(NEW)
R5416	1-216-077-00	RES,CHIP 15K	5% 1/10W	C2609	1-126-934-11	ELECT 220uF	20% 10V
R5417	1-216-308-00	RES,CHIP 4.7	5% 1/10W	C2610	1-104-664-11	ELECT 47uF	20% 25V
R5419	1-216-089-91	RES,CHIP 47K	5% 1/10W				(OLD)
R5420	1-249-383-11	CARBON 1.5	5% 1/4W F	C2610	1-126-934-11	ELECT 220uF	20% 10V
R5421	1-249-441-11	CARBON 100K	5% 1/4W F				(NEW)
R5422	1-215-885-00	METAL OXIDE 68	5% 2W F	C2611	1-126-934-11	ELECT 220uF	20% 10V
R5423	1-216-105-91	RES,CHIP 220K	5% 1/10W				(OLD)
R5501	1-216-057-00	RES,CHIP 2.2K	5% 1/10W	C2612	1-104-664-11	ELECT 47uF	20% 25V
R5502	1-216-681-11	METAL CHIP 18K	0.50% 1/10W				(NEW)
R5503	1-216-681-11	METAL CHIP 18K	0.50% 1/10W	C2613	1-126-934-11	ELECT 220uF	20% 10V
R5504	1-216-093-91	RES,CHIP 68K	5% 1/10W				(OLD)
R5505	1-216-067-00	RES,CHIP 5.6K	5% 1/10W	C2615	1-126-934-11	ELECT 220uF	20% 10V
R5506	1-216-670-11	METAL CHIP 6.2K	0.50% 1/10W				(OLD)
*****				C2617	1-163-021-91	CERAMIC CHIP 0.01uF	10% 50V
				C2901	1-164-004-11	CERAMIC CHIP 0.1uF	10% 25V
				C2902	1-104-664-11	ELECT 47uF	20% 25V
				C2903	1-104-664-11	ELECT 47uF	20% 25V
				C2904	1-104-664-11	ELECT 47uF	20% 25V
							(OLD)
				C2905	1-164-489-11	CERAMIC CHIP 0.22uF	10% 16V
				C2906	1-109-982-11	CERAMIC CHIP 1uF	10% 10V
							(OLD)
				C2908	1-109-982-11	CERAMIC CHIP 1uF	10% 10V
							(OLD)



REF.NO.	PART NO.	DESCRIPTION	REMARK	REF.NO.	PART NO.	DESCRIPTION	REMARK
C2909	1-163-243-11	CERAMIC CHIP 47pF	5% 50V				
C2910	1-163-275-11	CERAMIC CHIP 0.001μF	5% 50V				
C2911	1-104-664-11	ELECT 47μF	20% 25V				
C2912	1-163-229-11	CERAMIC CHIP 12pF	5% 50V				
C2914	1-109-982-11	CERAMIC CHIP 1μF	10% 10V (OLD)				
C2914	1-164-489-11	CERAMIC CHIP 0.22μF	10% 16V (NEW)				
C2915	1-109-982-11	CERAMIC CHIP 1μF	10% 10V (OLD)				
C2916	1-164-004-11	CERAMIC CHIP 0.1μF	10% 25V (NEW)				
<CONNECTOR>							
CN2601	1-785-120-11	PIN, CONNECTOR (PC BOARD) 9P					
CN2901	1-779-677-11	CONNECTOR, USB (B)					
CN2902	1-779-642-12	CONNECTOR, USB (A)					
CN2903	1-779-642-12	CONNECTOR, USB (A)					
CN2904	1-779-642-12	CONNECTOR, USB (A)					
CN2905	1-779-642-12	CONNECTOR, USB (A)					
CN2906	* 1-508-879-11	BASE POST					
<DIODE>							
D2601	8-719-911-19	DIODE 1SS119-25 (NEW)					
D2601	8-719-988-62	DIODE 1SS355 (OLD)					
D2602	8-719-911-19	DIODE 1SS119-25 (NEW)					
D2602	8-719-988-62	DIODE 1SS355 (OLD)					
D2603	8-719-911-19	DIODE 1SS119-25 (NEW)					
D2603	8-719-988-62	DIODE 1SS355 (OLD)					
D2604	8-719-911-19	DIODE 1SS119-25 (NEW)					
D2604	8-719-988-62	DIODE 1SS355 (OLD)					
D2605	8-719-988-61	DIODE 1SS355TE-17 (NEW)					
D2606	8-719-988-61	DIODE 1SS355TE-17 (NEW)					
D2607	8-719-988-61	DIODE 1SS355TE-17 (NEW)					
D2608	8-719-988-61	DIODE 1SS355TE-17 (NEW)					
D2609	8-719-158-15	ZENER DIODE RD5.6SB					
D2610	8-719-988-61	DIODE 1SS355TE-17 (NEW)					
D2902	8-719-422-12	DIODE MA8039					
D2903	8-719-422-12	DIODE MA8039					
D2904	8-719-158-15	ZENER DIODE RD5.6SB					
D2905	8-719-158-15	ZENER DIODE RD5.6SB					
D2906	8-719-158-15	ZENER DIODE RD5.6SB					
D2907	8-719-158-15	ZENER DIODE RD5.6SB					
D2908	8-719-422-12	DIODE MA8039					
D2909	8-719-422-12	DIODE MA8039					
D2910	8-719-422-12	DIODE MA8039					
D2911	8-719-422-12	DIODE MA8039					
D2912	8-719-422-12	DIODE MA8039					
D2913	8-719-422-12	DIODE MA8039					
D2914	8-719-422-12	DIODE MA8039					
D2915	8-719-422-12	DIODE MA8039					
<FERRITE BEAD>							
FB2601	1-412-911-11	FERRITE	1.1μH				
FB2901	1-412-911-11	FERRITE	1.1μH				
FB2903	1-412-911-11	FERRITE	1.1μH				
FB2904	1-412-911-11	FERRITE	1.1μH				
FB2905	1-412-911-11	FERRITE	1.1μH				
FB2906	1-412-911-11	FERRITE	1.1μH				
FB2911	1-412-911-11	FERRITE	1.1μH				
FB2912	1-216-295-91	SHORT	0				
FB2913	1-216-295-91	SHORT	0				
FB2914	1-216-295-91	SHORT	0				
FB2915	1-216-295-91	SHORT	0				
FB2916	1-216-295-91	SHORT	0				
FB2917	1-216-295-91	SHORT	0				
FB2918	1-216-295-91	SHORT	0				
FB2919	1-216-295-91	SHORT	0				
FB2924	1-216-295-91	SHORT	0				
FB2925	1-216-295-91	SHORT	0				
FB2932	1-412-911-11	FERRITE	1.1μH				
FB2933	1-412-911-11	FERRITE	1.1μH				
FB2934	1-412-911-11	FERRITE	1.1μH				
FB2935	1-412-911-11	FERRITE	1.1μH				
<IC>							
IC2601	8-759-521-90	IC PQ05DZ5U					
IC2602	8-759-157-22	IC PQ05TZ1U (NEW)					
IC2602	8-759-535-22	IC μCC38531N (OLD)					
IC2603	8-759-157-22	IC PQ05TZ1U (NEW)					
IC2604	8-759-157-22	IC PQ05TZ1U (NEW)					
IC2605	8-759-157-22	IC PQ05TZ1U (NEW)					
IC2606	8-759-140-85	IC μPC1093J (NEW)					
IC2901	8-759-542-53	IC TUSB2040PT (OLD)					
IC2902	8-759-165-87	IC PST600J-T					
<COIL>							
L2901	1-412-003-41	INDUCTOR CHIP	5.6μH				
<TRANSISTOR>							
Q2601	8-729-028-83	TRANSISTOR DTA124EUA-T106 (OLD)					
Q2601	8-729-119-76	TRANSISTOR 2SA1175-HFE (NEW)					
Q2602	8-729-028-83	TRANSISTOR DTA124EUA-T106 (OLD)					
Q2602	8-729-119-76	TRANSISTOR 2SA1175-HFE (NEW)					
Q2603	8-729-028-83	TRANSISTOR DTA124EUA-T106 (OLD)					
Q2603	8-729-119-76	TRANSISTOR 2SA1175-HFE (NEW)					
Q2604	8-729-028-83	TRANSISTOR DTA124EUA-T106 (OLD)					
Q2604	8-729-119-76	TRANSISTOR 2SA1175-HFE (NEW)					
Q2605	8-729-028-74	TRANSISTOR DTA114TUA-T106 (NEW)					
Q2606	8-729-029-06	TRANSISTOR DTC124EUA-T106 (NEW)					
Q2607	8-729-028-83	TRANSISTOR DTA124EUA-T106 (NEW)					

GDM-F500/F500T9



REF.NO.	PART NO.	DESCRIPTION	REMARK	REF.NO.	PART NO.	DESCRIPTION	REMARK
		<RESISTOR>		R2617	1-216-882-00	METAL OXIDE 22	5% 2W F (NEW)
R2601	1-216-057-00	RES,CHIP 2.2K	5% 1/10W	R2618	1-216-129-00	RES,CHIP 2.2M	5% 1/10W (OLD)
R2602	1-216-371-00	METAL OXIDE 1.5	5% 2W F (NEW)	R2618	1-216-663-11	METAL CHIP 3.3K	0.50%1/10W (NEW)
R2602	1-216-375-00	METAL OXIDE 3.3	5% 2W F (OLD)	R2619	1-216-129-00	RES,CHIP 2.2M	5% 1/10W (OLD)
R2603	1-216-346-00	METAL OXIDE 0.56	5% 1W F (NEW)	R2619	1-216-675-11	METAL CHIP 10K	0.50%1/10W (NEW)
R2603	1-216-375-00	METAL OXIDE 3.3	5% 2W F (OLD)	R2620	1-216-049-91	RES,CHIP 1K	5% 1/10W (NEW)
R2604	1-216-049-91	RES,CHIP 1K	5% 1/10W (NEW)	R2621	1-216-049-91	RES,CHIP 1K	5% 1/10W (NEW)
R2604	1-216-373-11	METAL OXIDE 2.2	5% 2W F (OLD)	R2622	1-216-129-00	RES,CHIP 2.2M	5% 1/10W (NEW)
R2605	1-216-089-91	RES,CHIP 47K	5% 1/10W (OLD)	R2625	1-216-057-00	RES,CHIP 2.2K	5% 1/10W (OLD)
R2605	1-216-371-00	METAL OXIDE 1.5	5% 2W F (NEW)	R2626	1-216-057-00	RES,CHIP 2.2K	5% 1/10W (OLD)
R2606	1-216-346-00	METAL OXIDE 0.56	5% 1W F (NEW)	R2627	1-216-057-00	RES,CHIP 2.2K	5% 1/10W (OLD)
R2606	1-216-375-00	METAL OXIDE 3.3	5% 2W F (OLD)	R2901	1-216-009-00	RES,CHIP 22	5% 1/10W (OLD)
R2607	1-216-049-91	RES,CHIP 1K	5% 1/10W (NEW)	R2901	1-216-017-91	RES,CHIP 47	5% 1/10W (NEW)
R2607	1-216-375-00	METAL OXIDE 3.3	5% 2W F (OLD)	R2902	1-216-057-00	RES,CHIP 2.2K	5% 1/10W
R2608	1-216-371-00	METAL OXIDE 1.5	5% 2W F (NEW)	R2903	1-216-061-00	RES,CHIP 3.3K	5% 1/10W (OLD)
R2608	1-216-375-00	METAL OXIDE 3.3	5% 2W F (OLD)	R2903	1-216-067-00	RES,CHIP 5.6K	5% 1/10W (NEW)
R2609	1-216-057-00	RES,CHIP 2.2K	5% 1/10W (OLD)	R2904	1-216-295-91	SHORT 0	(OLD)
R2609	1-216-346-00	METAL OXIDE 0.56	5% 1W F (NEW)	R2905	1-216-295-91	SHORT 0	(OLD)
R2610	1-216-049-91	RES,CHIP 1K	5% 1/10W (NEW)	R2912	1-216-295-91	SHORT 0	(OLD)
R2611	1-216-295-91	SHORT 0	(OLD)	R2915	1-216-053-00	RES,CHIP 1.5K	5% 1/10W
R2611	1-216-371-00	METAL OXIDE 1.5	5% 2W F (NEW)	R2916	1-216-077-00	RES,CHIP 15K	5% 1/10W
R2612	1-216-129-00	RES,CHIP 2.2M	5% 1/10W (OLD)	R2919	1-216-077-00	RES,CHIP 15K	5% 1/10W
R2612	1-216-346-00	METAL OXIDE 0.56	5% 1W F (NEW)	R2920	1-216-077-00	RES,CHIP 15K	5% 1/10W
R2613	1-216-049-91	RES,CHIP 1K	5% 1/10W (NEW)	R2923	1-216-077-00	RES,CHIP 15K	5% 1/10W
R2614	1-216-073-00	RES,CHIP 10K	5% 1/10W (NEW)	R2924	1-216-077-00	RES,CHIP 15K	5% 1/10W
R2614	1-216-089-91	RES,CHIP 47K	5% 1/10W (OLD)	R2925	1-216-077-00	RES,CHIP 15K	5% 1/10W
R2615	1-216-073-00	RES,CHIP 10K	5% 1/10W (NEW)	R2926	1-216-077-00	RES,CHIP 15K	5% 1/10W
R2615	1-216-089-91	RES,CHIP 47K	5% 1/10W (OLD)	R2927	1-216-009-00	RES,CHIP 22	5% 1/10W (OLD)
R2616	1-216-073-00	RES,CHIP 10K	5% 1/10W (NEW)	R2927	1-216-017-91	RES,CHIP 47	5% 1/10W (NEW)
R2616	1-216-089-91	RES,CHIP 47K	5% 1/10W (OLD)	R2928	1-216-009-00	RES,CHIP 22	5% 1/10W (OLD)
R2617	1-216-129-00	RES,CHIP 2.2M	5% 1/10W (OLD)	R2928	1-216-017-91	RES,CHIP 47	5% 1/10W (NEW)
				R2930	1-216-009-91	RES,CHIP 22	5% 1/10W
				R2931	1-216-009-91	RES,CHIP 22	5% 1/10W
				R2932	1-216-077-00	RES,CHIP 15K	5% 1/10W
				R2933	1-216-009-00	RES,CHIP 22	5% 1/10W (OLD)
				R2933	1-216-017-91	RES,CHIP 47	5% 1/10W (NEW)
				R2934	1-216-009-00	RES,CHIP 22	5% 1/10W (OLD)



REF.NO.	PART NO.	DESCRIPTION		REMARK
R2934	1-216-017-91	RES,CHIP	47	5% 1/10W (NEW)
R2935	1-216-009-00	RES,CHIP	22	5% 1/10W (OLD)
R2935	1-216-017-91	RES,CHIP	47	5% 1/10W (NEW)
R2941	1-216-009-00	RES,CHIP	22	5% 1/10W (OLD)
R2941	1-216-017-91	RES,CHIP	47	5% 1/10W (NEW)
R2942	1-216-009-00	RES,CHIP	22	5% 1/10W (OLD)
R2942	1-216-017-91	RES,CHIP	47	5% 1/10W (NEW)
R2943	1-216-295-91	SHORT	0	(OLD)
R2944	1-216-295-91	SHORT	0	(OLD)
R2945	1-216-295-91	SHORT	0	(OLD)
R2947	1-216-295-91	SHORT	0	(OLD)
R2948	1-216-295-91	SHORT	0	(OLD)
R2949	1-216-295-91	SHORT	0	(OLD)
R2950	1-216-295-91	SHORT	0	(OLD)
R2951	1-216-295-91	SHORT	0	(OLD)
R2952	1-216-295-91	SHORT	0	(OLD)
R2953	1-216-295-91	SHORT	0	(OLD)
R2954	1-216-295-91	SHORT	0	(OLD)
R2955	1-216-295-91	SHORT	0	(OLD)
R2956	1-216-295-91	SHORT	0	(OLD)
R2957	1-216-295-91	SHORT	0	(OLD)
R2958	1-216-295-91	SHORT	0	(OLD)
R2959	1-216-295-91	SHORT	0	(OLD)

<TRANSFORMER>

T2601 1-416-762-11 COIL, CHOKE

<CRYSTAL>

X2901 1-767-587-31 VIBRATOR, CRYSTAL (48MHz)

